

INSTRUCTION MANUAL

Model: 6502/04/06

20/40/60MHz 4Trace

Oscilloscope

Protek

INSTALLATION CATEGORY INFORMATION

This instrument may be damaged if operated with LINE VOLTAGE(AC 100/120/220/230V $\pm 10\%$) set for the wrong applied ac input-source voltage or if the wrong line fuse is installed. Before connecting the power cord to a power input-source is set for the correct nominal ac input-source voltage and line fuse.

The power-source must be stand where put out easily when happen a problem of instrument

(Safety precaution)

This oscilloscope is equipped with a grounding terminal on the front panel, to protect the body and prevent electric shock. Make sure this grounding connector is connected to ground prior to use.

Warning : Sources like small hand-held radio transceivers, fixed station radio and television transmitters, vehicle radio transmitters and cellular phones generate electromagnetic radiation that may induce voltages in the leads of a test probe. In such cases the accuracy of the oscilloscope cannot be guaranteed due to physical reasons.

Contents

1. Introduction	4
2. Features	4
3. Configuration	4
4. Precautions to be taken to ensure long life	5
5. Description of operating controls	8
6. How to display a trace	16
7. Signal connections	18
8. Measuring procedures	20
9. Specifications	25
10. Repair and storage	28
11. External drawing	29

1. Introduction

Thank you for purchasing the Model 6500 oscilloscope.

In order to ensure long equipment life, please read this manual carefully prior to use. Retain this manual together with the warranty sheet, after reading.

Scope of warranty

This oscilloscope has been manufactured under rigid quality control standards and distributed only after thorough inspection.

Should any breakdown occur during normal operation, repairs shall be carried out in accordance with the provisions of the "Warranty" attached to this manual.

After-sales Service

Manufactured taking into consideration oscilloscope has been designed, manufactured and inspected to ensure the best operation under all operating conditions, following a variety of environmental tests.

Should any breakdown occur, contact any of our offices or dealers to receive prompt and efficient after-sales services.

Caution

Depending on the way this oscilloscope is handled, the trace may become slightly slanted to the horizontal scale. Should this happen, adjust the trace rotation locator on the front panel and adjust the trace to the horizontal center of the graduation.

2. Features

This compact, light weight model 6500 series oscilloscope has a frequency range of DC-60MHz, [DC-40MHz] or (DC-20MHz), and offers the following features:

- 1) Wide frequency range : Frequencies up to DC-60MHz, [DC-40MHz] or (DC-20MHz).
- 2) High sensitivity : 1mV/div
- 3) Large size CRT : Waveforms are easy to read, on the large 6-inch CRT with an internal graticule scale.
- 4) Scale : Waveforms are parallax-free with the CRT's internal graticule scale.
- 5) Alt Mag : The normal(x1) and the x10(x5) magnified waveforms can be displayed simultaneously.
- 6) Alt Trig : Stabilized triggering is accomplished even with two unrelated signals.
- 7) TV synchronization : Stable TV signals are displayed using new circuitry
- 8) Auto focus : Focus deviation is automatically corrected

3. Configuration

The Standard accessories supplied are as follows:

- | | |
|------------------------|---|
| 1) Oscilloscope | 1 |
| 2) Probe | 2 |
| 3) Power cord | 1 |
| 4) User's manual | 1 |

4. Precautions to be taken to ensure long life

4-1. Storage and operation

- 1) Avoid extremes of heat or cold

Do not place oscilloscope in direct sun light for long periods; Store in a closed, unventilated vehicle in hot summer weather, or near heating equipment, such as stoves.

- 2) Do not use outdoors in cold weather, Optimum operating temperature range is 0°C to 40°C

- 3) Movement from warm location to cold one, and vice versa

Do not move oscilloscope abruptly from warm location to cold location, or vice versa.

This could result in condensation forming inside the instrument.

- 4) Avoid humidity, moisture and dust

If oscilloscope is left in a humid or dusty location, this could result in instrument failure.

Ideal operating relative humidity range is 35% to 85%.

Never place containers of liquid such as cups of coffee on top of oscilloscope, as this could result in spilling in the instrument, inducing failure.

- 5) Avoid areas subject to severe vibration

Avoid places where severe vibration can occur, this may result in machine failure, this is a precision measuring instrument.

- 6) Beware of places where magnets and magnetic fields are present

An oscilloscope is an instrument which operates using electromagnetic properties. Never place magnets near your oscilloscope, or operate oscilloscope in the vicinity of equipment which produces strong magnetic fields.

4-2. Handling

- 1) Do not place objects on top of oscilloscope, and take care not to block the ventilation holes.

- 2) Do not subject oscilloscope to severe impact

- 3) Do not insert wires or pins into the ventilation holes.

- 4) Do not pull equipment by the probes

- 5) Push both ends of carrying handle to release the locking device to deploy the handle.

- 6) Never place a soldering iron on the oscilloscope frame, or on surface of the CRT tube.

- 7) Do not sit the oscilloscope upside down

4-3. Sitting the oscilloscope upside down may damage the handle or other parts.

Do not use oscilloscope with BNC cable connected to Ext input terminal on rear panel.













4-4. If the oscilloscope does not operate normally

Recheck operating procedures and, if the symptoms indicate equipment failure, contact your nearest dealer or store for service.

4-5. Repairs

1) To clean the case

- To clean stained casing, lightly rub the stained area with a soft cloth dipped in a neutral detergent.
- If the surface of the panel is dirty, use the same method to clean. If the panel is heavily stained, rub the affected area lightly with a soft cloth soaked in light neutral detergent or alcohol.
- Never use highly volatile material such as benzene or paint thinner.

NO.	SYMBOL	DESCRIPTIONS	NO.	SYMBOL	DESCRIPTIONS
1		Direct current	7		OFF (SUPPLY)
2		Alternating Current	8		Equipment protected throughout by DOUBLE INSULATION or REINFORCED INSULATION (equivalent to class II of IEC 536-see annex H)
3		Earth (ground) TERMINAL	9		Caution, risk of electric shock Easily-touched higher temperature parts
4		PROTECTIVE CONDUCTOR TERMINAL	10		Caution (refer to accompanying documents)
5		Frame or chassis TERMINAL	11		In-position of a bistable push control
6		ON (SUPPLY)	12		Out-position of a bistable push control

4-6. Precautions prior to use

1) Verify the line voltage.

Refer to the following table for the correct operating voltage ranges for this oscilloscope. Check line voltage prior to connecting to the power source, and verify it is within a voltage range listed below.

Rating	Operating Voltage Range
AC 100V	AC 90V to 110V
AC 120V	AC 108V to 132V
AC 220V	AC 198V to 242V
AC 230V	AC 207V to 253V

This oscilloscope has been set to 120V AC prior to delivery

If the oscilloscope is to be used at a voltage other than the 120V AC the operating voltage may be changed by the following procedure:

- Remove power cable from AC Input.
- Insert flat-blade screwdriver into the slot located on right side of the fuse holder cap, remove cap by pressing and then pulling up the screw driver.
- Rotate cap on fuse holder to set voltage to the desired level.
- Connect power cable to the AC Input.

If voltage higher than AC 220V is required, power cable and fuse may need to be changed.

In such case, contact your nearest dealer for appropriate service.

2) In sure that the fuse used is an authorized product.

In order to prevent circuit damage resulting from overcurrent, use the correct fuse value for the primary circuit.

	20MHz, 40MHz, 60MHz
For AC 100V, AC 120V	250V F 2A
For AC 220V, AC 230V	250V F 1A

If the fuse blows, check for the cause. Replace the fuse with the correct one after repair has been made.

If other than the correct fuse is used, not only does this create conditions for failure, but is also dangerous.

Therefore, always use the correct fuse value(In particular, never use any component which does not meet current ratings)

The fuse ratings are as follows:

	Shape (Diameter x length) mm	SPEC
2A	5.2 ϕ x 20	250V F 2A
1A	5.2 ϕ x 20	250V F 1A

3) Do not turn the intensity too bright.

Do not excessively brighten the dot or trace, this not only tires the eyes but, if allowed for long periods of time, could burn the fluorescent side of the CRT.

4) Exercise caution to prevent excessive voltage from being applied directly to the scope inputs or to the probe input. Do not apply voltages higher than these limits:

Vertical Inputs (Direct)	400V (At DC + AC peak 1kHz)
EXT TRIG INPUT	400V (At DC + AC peak 1kHz)
Z-Axis Input	30V (DC + AC peak)

* This instrument is Installation Category (Over voltage Category) : II

5. Description of operating controls

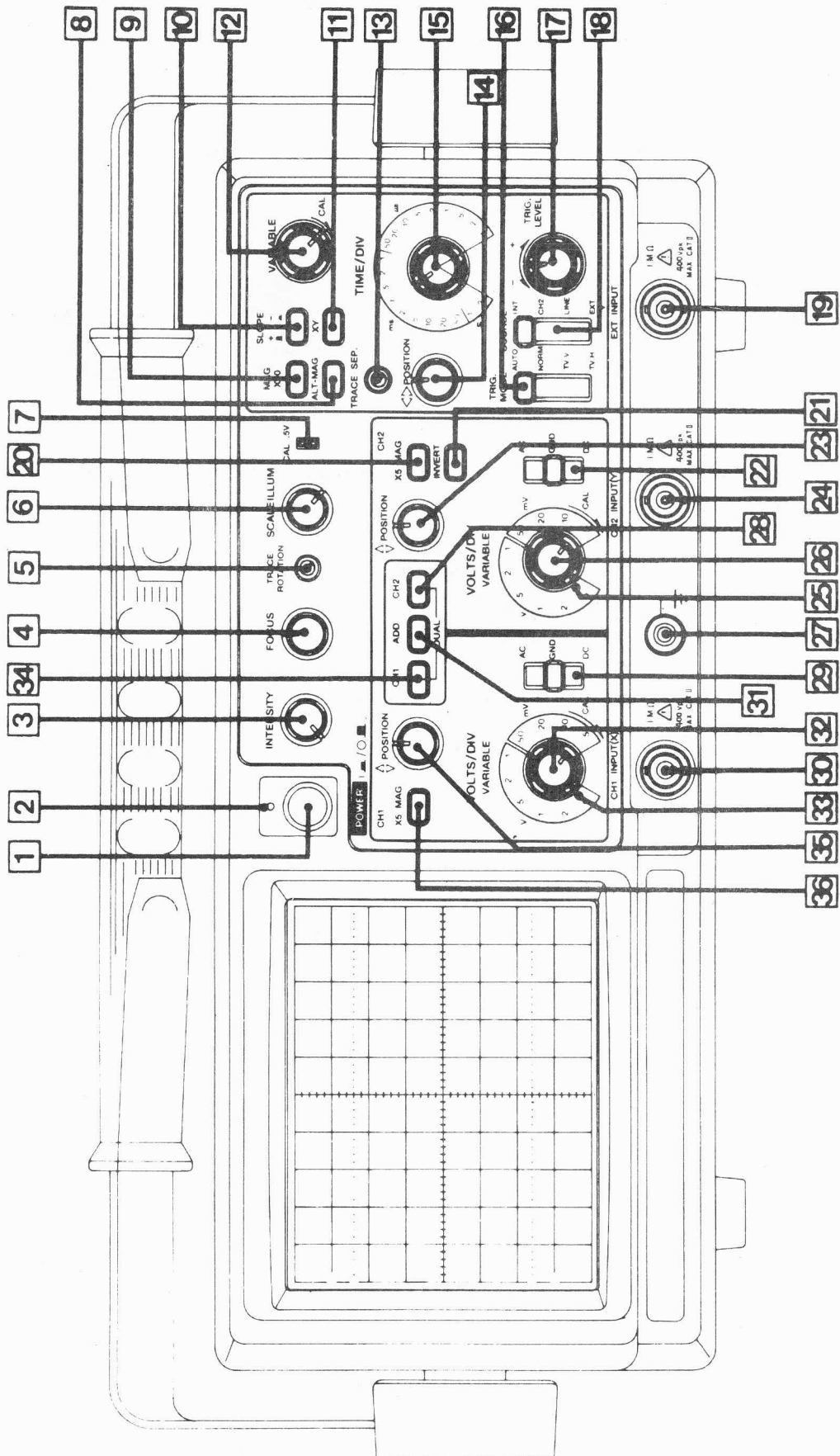

5-1 60MHz, 40MHz Front Panel

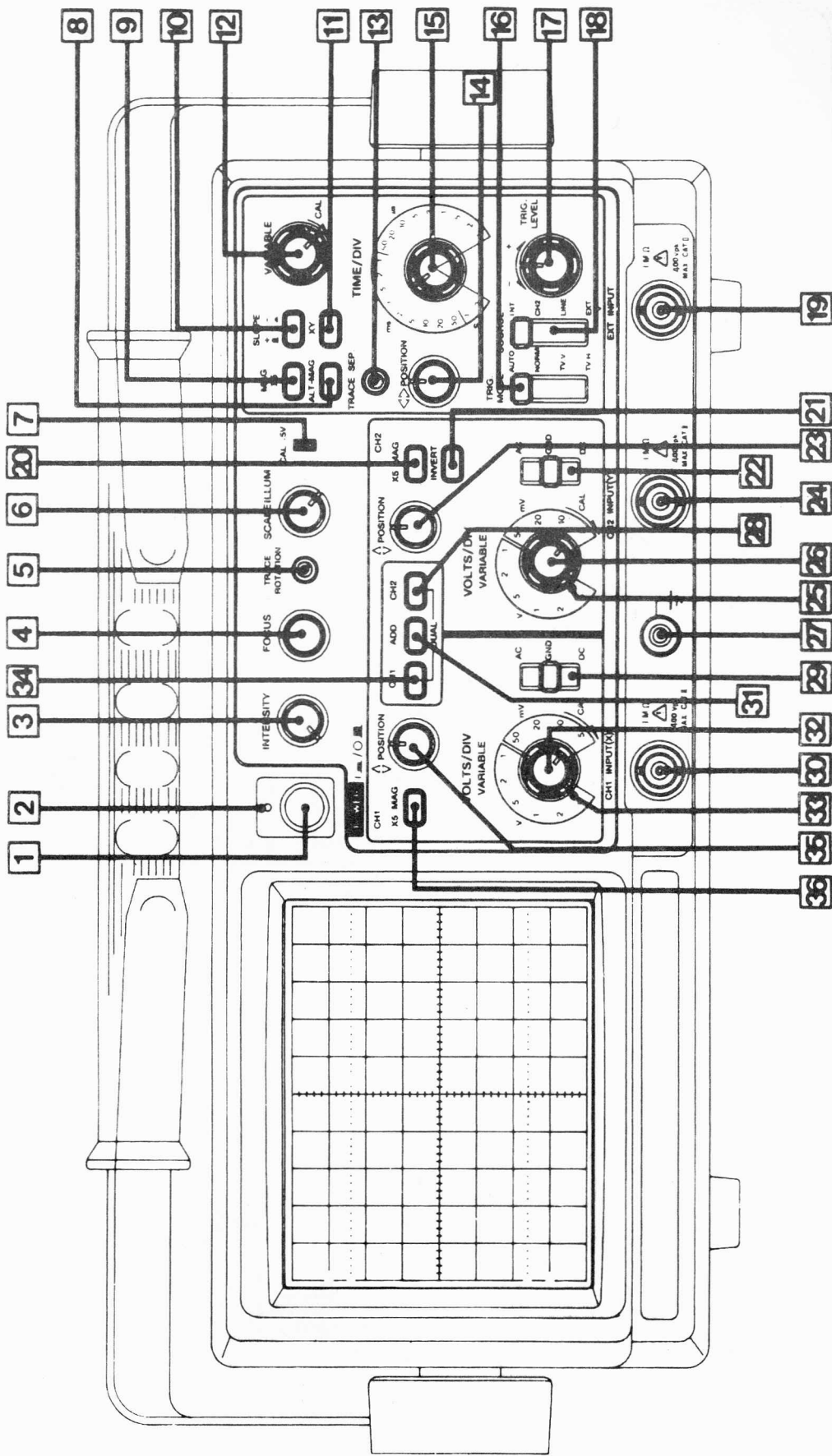

5-2 20MHz Front Panel

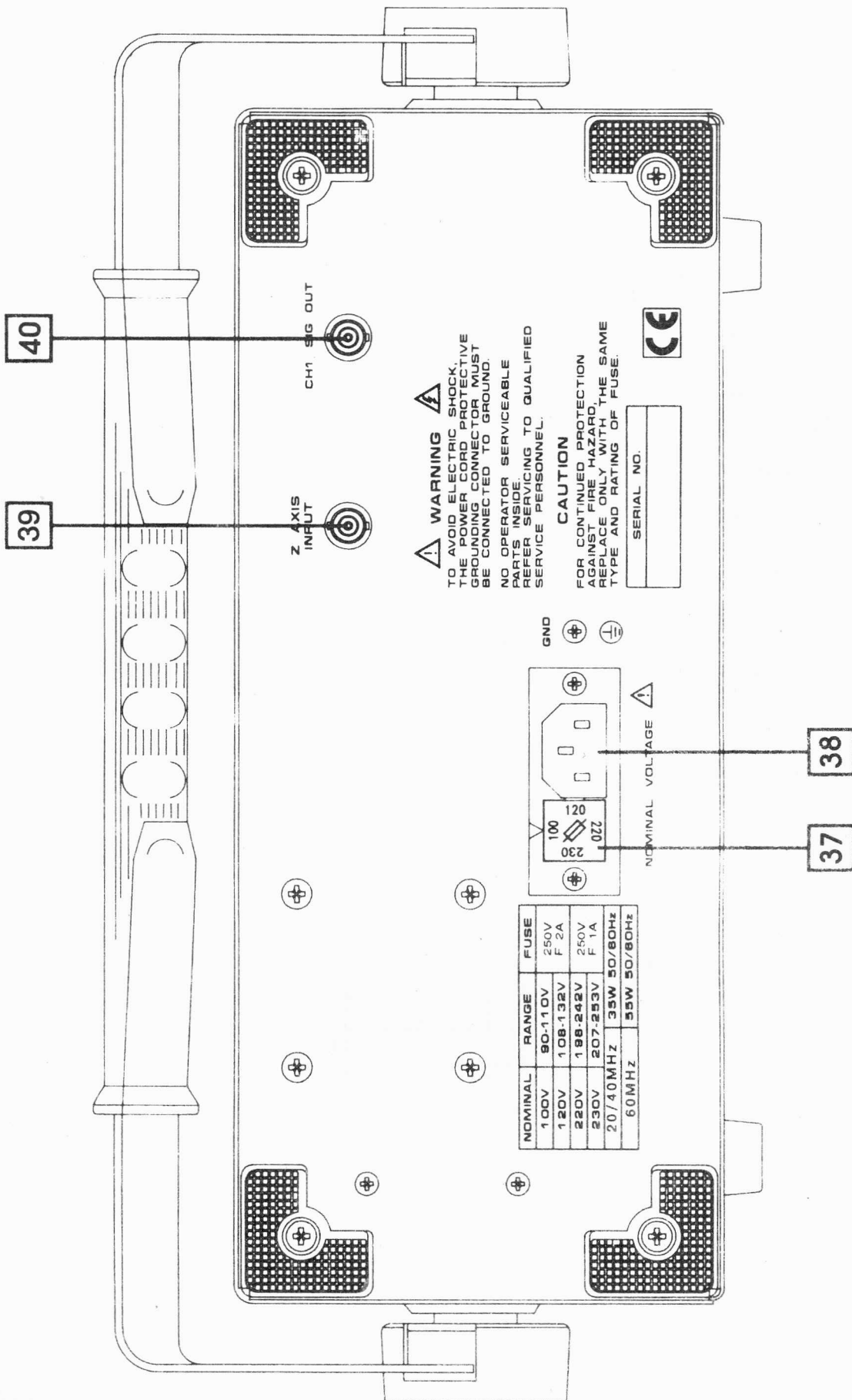

5-3 60MHz, 40MHz, 20MHz Rear Panel

5-1. Power supply and CRT

Fuse, AC input

Insert the power cable into the AC Input receptacle (38), and apply the line voltage indicated by the line voltage converter on the rear panel (37).

Check rated voltage indicated on the voltage selector, and use the corresponding fuse.

1) Power switch ON/OFF

Verify line voltage; set power switch to the OFF position and insert power cable in to the receptacle AC.

Press power push-button switch to turn the power on. If the switch is released, the power is turned off.

2) Power lamp

This lamp lights when power is turned ON.

3) Intensity knob

Turning this knob clockwise, brightness is increased.

Turn the knob fully counterclockwise prior to connecting power.

4) Focus knob

Adjust the brightness to an appropriate level with the intensity control, then adjust the focus control until the trace is at its clearest level.

Although the focus is automatically set by adjusting the intensity, the focus sometimes may be slightly out.

If this happens, readjust the focus.

5) Trace rotation

This knob is used to correct the horizontal trace when it becomes slanted with respect to the horizontal scale, due to the effect of magnetic forces.

6) Scale Illum knob

This is used to adjust scale brightness. If this knob is turned clockwise, brightness is increased. This feature is useful for operation in dark locations, or when taking pictures.

37) Fuse-holder/Line voltage converter(Rear panel): - Selects the line voltage supplied to the oscilloscope.

38) AC Receptacle(Rear panel)

This is the connector for the AC power cable.

5-2. Vertical axis section

30) CH 1 input connector

This is a BNC connector used for vertical input. The signal applied to this connector when in the X-Y mode becomes the Y-axis signal.

24) CH 2 input connector

Same as CH 1; however, the signal applied to this connector when in the X-Y mode, becomes the X-axis signal.

22), 29) AC-GND-DC switch

Selects the coupling method to the vertical amplifier.

AC : The vertical input is connected through a capacitor. The DC component of the input signal is blocked, and the AC component only is displayed.

GND : Input of vertical amplifier is grounded.

DC : Directly coupled. Input signal, including DC component, is displayed on the CRT.

25), 33) Volts/Div selector switch

This is a step attenuator switch which varies the vertical deflection sensitivity. Set to the position which displays the input signal at the most convenient height on the CRT.

If a 10:1 probe is used, calculate as 10-times the height

26), 32) Var Knob

The fine adjustment is used for varying the vertical axis deflection sensitivity continuously.

If this knob is turned completely counter clockwise the vertical, sensitivity is reduced to less than 1/2.5 of VOLTS/Div switch setting. This knob is used for comparing two waveforms and rise time measurements.

However, this is normally in the fully clockwise position.

20), 36) When the x5 Mag Button is pressed, the vertical axis gain is magnified 5 times, the maximum sensitivity becomes 1mV/Div.

23), 35) Position

Used to move the CH1 or CH2 trace up or down on the CRT screen.

21) Invert Push Button Switch

When the invert push button 21) is pressed, the polarity of the input signal applied to CH2 is inverted.

This function is convenient when 2 waveforms of different polarities are compared, or for displaying the CH1 and CH2 difference waveform using ADD.

Vertical Mode Push Buttons : Selects Vertical axis operating mode.

34) CH1 : Only the signal applied to CH1 is displayed on the screen.

28) CH2 : Only the signal applied to CH2 is displayed on the screen.

34), 28) Dual : When both CH1 and CH2 buttons are pushed in, the signals applied to CH1 and CH2 input are displayed simultaneously on the CRT in either chopped or alternate display.

31) ADD : Displays the algebraic sum of the CH1 and CH2 input voltage. (The difference voltage is displayed when the CH2 invert push button is pushed in.)

40) CH1 Signal Output Connector (Rear panel)

Provides a 20mV/Div replica of the CH1 input signal for use with a frequency counter.

NOTE: Only in the 6502A Oscilloscope:

(34) CH1/CH2: In the one channel mode, the function used to select CH1 or CH2. Then in the dual channel mode, used to select inner trigger source CH1 or CH2.

(28) CHOP: The signals applied to CH1 and CH2 input are displayed on the CRT in chopped display.

(31) ALT: The signals applied to CH1 and CH2 input are displayed on the CRT in alternate display.

5-3. Horizontal axis section

15) Time/Div selector switch

Selects sweep speed from 0.1us/Div to 0.2s/Div in 20 calibrated steps.

11) X,Y

Displays the CH1 and CH2 input signal as an X, Y graph. The vertical deflection signal is applied to the CH1 input and the horizontal deflection signal is applied to the CH2 input.

The CH2 23) vertical position control is used for the positioning the X, Y display on the Vertical axis and the Horizontal position control 14) position the X, Y display on Horizontal axis of the CRT.

12) Sweep Var Control

When this knob is turned all the way clockwise (CAL) the sweep is indicated by the Time/Div switch. If the knob is turned all the way counterclockwise the sweep is less than 1/2.5 of the Time/Div setting. During normal operation, this knob is turned to the CAL position.

14) Horizontal Position

The trace can be moved in a horizontal direction. This is used for measuring waveform time duration

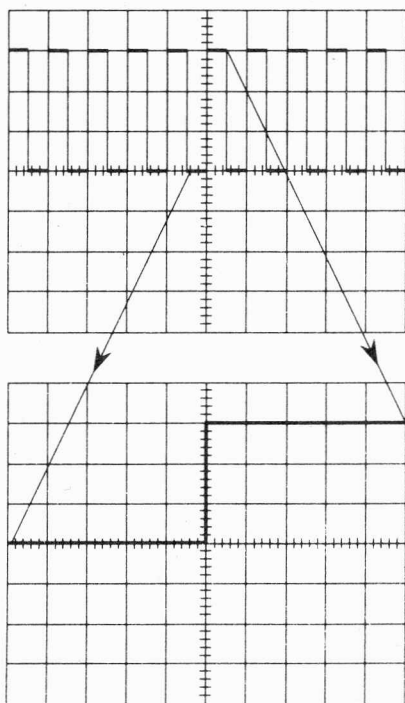

Expanded waveform

Push x 10MAG operation
(Push x 5MAG operation)

Turning this knob clockwise moves the trace towards the right, turning the knob counterclockwise moves the trace towards the left.

9) (x5) x10 Push Button

When pressed, the trace will be magnified by a factor of 10, (5)

The sweep time becomes 1/10(1/5) of the value indicated on the Time/Div switch.

(e.g. 100 μ s/Div becomes 10 μ s/Div for x10 MAG, 20 μ s/Div for x5 MAG)

To magnify a portion of waveform: Move the waveform of interest to the center graticule on the horizontal scale, press the x10, (x5)MAG button, the waveform will now be magnified from left to right, by a factor of 10 times (5 Times)

8) ALT MAG KNOB

Displays both the normal trace whose sweep rate is indicated by the Time/Div switch and the magnified trace x10 (x5) simultaneously on the CRT.

The magnified trace maybe positioned 1.5 Divisions or more from the normal trace with the trace separation control (13)

Four traces maybe displayed simultaneously on the CRT by using the Dual vertical mode and ALT-MAG

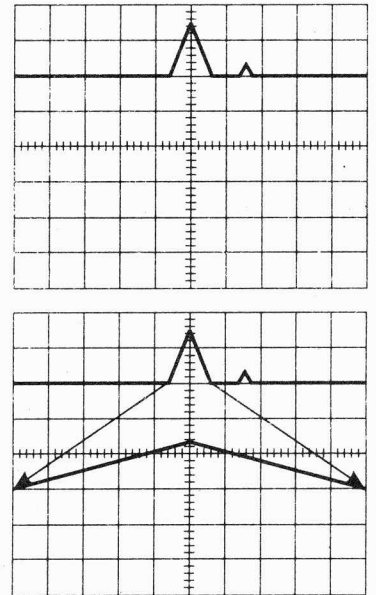

ALT. MAG operation

5-4. Triggering

18) Trigger source selector switch
selects sweep trigger signal source.

Int : The input signal applied to CH1 or CH2 becomes the trigger signal

CH2 : The input signal applied to CH2 becomes the trigger signal

Line : The power line frequency becomes the trigger signal source

Ext : The external signal applied to TRIG input becomes the trigger signal.

This is used when the trigger signal is external to the vertical input signal.

19) Ext input connector

The input terminal for the external trigger signal.

17) Trig level knob

This control sets the amplitude point on the trigger waveform that will start the sweep.

10) Slope knob

Selects the polarity of the slope the trigger source waveform will start the sweep.

(+) slope is selected when the push button is out.

(-) slope is selected when the push button is pushed in.

Description of trigger polarity

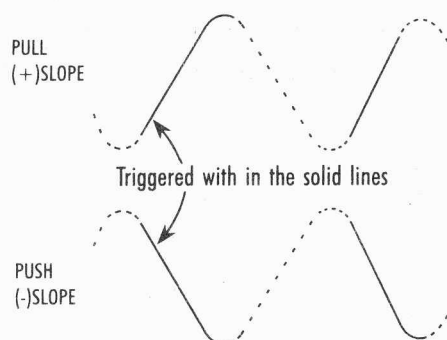

Description of trigger level

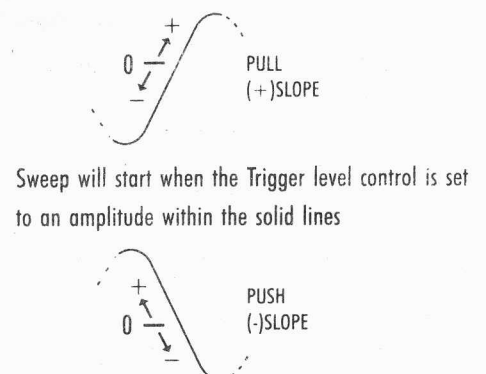

16) Trig mode switch

Auto : Sweep continuously runs in the auto sweep mode.

A trace will be displayed even when there is no input signal or when the input waveform is not triggered.

A stationary waveform will be displayed when the input waveform is properly triggered.

Norm : A trace will be displayed only when the input waveform is present and is properly triggered.

There will be no trace displayed on the CRT if there is no input signal or if the input signal is not synchronized.

Normal sweep is used when the input signal's frequency is less than 25Hz.

TV-H : Effective when trig mode is set to TV, and is used when the horizontal of the TV signal is to be synchronized.

TV-V : Effective only when trig mode is set to TV, and is used when the vertical of the TV signal is to be synchronized.

Note : Both TV-V and TV-H are synchronized only when the trigger signal is (-)

39) Z-Axis input connector (rear panel)

This is an input connector for intensity modulating the CRT beam because this is an integrated DC system, the (+) signal reduces brightness, while the (-) signal increases the brightness.

7) Cal 0.5V terminal

Outputs a 0.5V p-p 1kHz Rectangular wave for calibrating probes.

27) GND terminal

This is the grounding terminal.

6. How to display a trace

Check input line voltage prior to turning on the power switch. If the voltage selector switch has been set to 120V AC, verify that input power voltage is within the range of 108V~132V. Refer to rear panel illustrations for selection of input line voltage. Insert the power cord into the rear panel AC receptacle, and set each control as follows:

POWER	OFF (<input type="checkbox"/>)
INTENSITY	Turn all the way counterclockwise
FOCUS	Center
AC-GND-DC	GND
VERTICAL POSITION	Center [x5MAG knob in the off (<input type="checkbox"/>) position]
MODE	CH1
TRIG MODE	AUTO
TRIG SOURCE	INT
TRIG LEVEL	Center
A TIME/Div	0.5ms/Div
HORIZONTAL POSITION	Center [x10MAG][x5 MAG] are turned off (<input type="checkbox"/>)

After the controls have been set as above, turn on the power switch. The trace will appear when the Inten Knob is turned clockwise, in approximately 15 seconds. Adjust focus knob until the traces are at their clearest.

If the oscilloscope is not being used while the power is on, turn INTEN knob counter clockwise to reduce brightness.

1) Caution

For normal operation, set the following variable controls to the "CAL" position.

V/Div VAR. The Volts/Div is calibrated to the indicated values on the V/Div switch when turned fully clockwise.

SWP VAR The Time/Div is calibrated to the indicated values on the Time/Div switch when turned fully clockwise.

Set the trace to the horizontal graticule scale on the center of the screen, by varying the CH1 position control.

If the trace is slanted with respect to the horizontal scale adjust the front panel trace rotation control until the trace is coincident with the horizontal scale.

General Check

6-1. Displaying 1 waveform on the CRT

If using channel 1, set the switches as follows:

Vertical axis mode switch CH1

Trig mode switch Auto

Trig source switch INT

When these setting have been completed, most repetitive signals of a frequency greater than approximately 25Hz will become synchronized by adjusting the trig level control and can be measured.

Since the trigger mode is in Auto, the trace appears even when there is no signal, applied or when the AC-GND-DC switch is set to GND, a DC voltage can also be displayed if the AC-GND-DC switch is set to DC.

If low-frequency signals less than 25Hz are applied to CH1, the following changes are required

Trig mode switch Norm

Adjust the trigger level control to synchronize the trace.

If using CH2 input, set these switches:

Vertical axis mode switch to CH2

Trig source switch to CH2

All other settings and steps are the same as for displaying a waveform on CH1.

6-2. When 2 waveforms are to be observed

Set the vertical axis mode switch to Dual, both waveforms now can be easily display; If the Time/Div range is changed, the scope will automatically select ALT or CHOP.

If a phase difference is being measured, the signal with a leading phase must be the trigger signal.

6-3. Displaying an X-Y pattern

When the X-Y switch is pressed, the oscilloscope will be an X-Y display with the signal applied to the CH1 input, as the X-Axis and the signal applied to CH2 as the Y-Axis.

Set the vertical axis x10MAG (x5 MAG)switch to off (pulled-out state.)

6-4. Use of ADD

When the vertical mode switch is set to ADD, the algebraic sum of 2 waveforms can be displayed.

7. Signal connection

Pay particular attention to this, because the first step in measurement is to accurately input the signal to the oscilloscope.

7-1. When probes are being used

Use the probes to accurately measure high-frequency signals because the input signals are reduced to 1/10 of their value, this may be unsuitable the case of low level signals. However, in the case of large amplitude signals, the measuring range is widened proportionally.

1) Caution

- Do not apply signals which exceed 400V (DC + AC peak 1kHz).
- If a fast rise time, or a high-frequency signal is being measured, place the grounding lead of the probe near the point being measured. If the ground lead is long, waveform distortion, such as ringing or overshoot, may be generated.

2) handling of the ground lead



- The actual Volts/Div value is 10 times greater than the displayed value. For example, if Volts/Div is set to 50m/Div, the actual value is $50\text{mV/Div} \times 10 = 500\text{mV/Div}$.
- To avoid measurement errors, calibrate the probe as follows, and double check prior to taking measurements. Connect the probe tip to the CAL output connector 1kHz. If the compensation capacitance value is optimized, the waveform will look like that shown in Fig. 1 (a). If the waveforms are as shown in Fig. 1 (b) and (c), adjust the capacitance to the optimum value level using the variable capacitor(trimmer), in the probe housing.

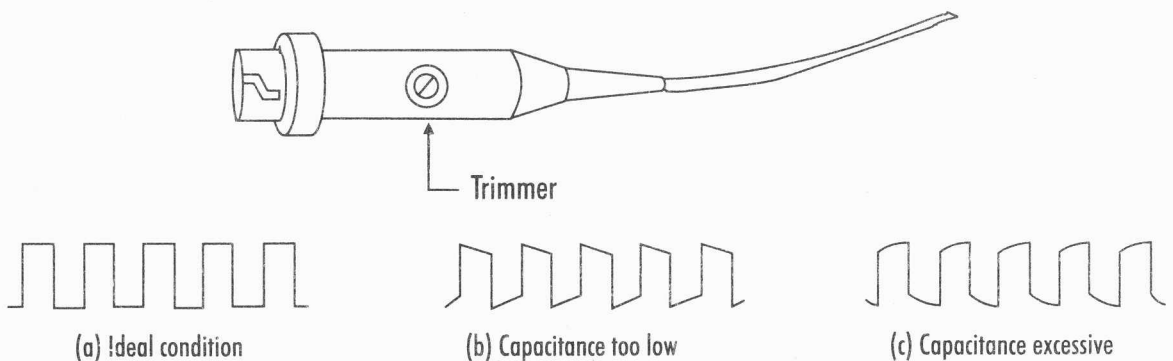

Fig. 1

7-2 Direct connection

If signals are directly connected to the oscilloscope without using probes take the following precautions to minimize measurement errors.

- A bare wire may be used for an input lead if the circuit to be measured is low impedance, or high amplitude level; however, take precautions, because in many cases, measurement errors may occur due to electrostatic coupling generated from multiple circuits or power lines.

Such measurement errors cannot be disregarded even at low-frequency.

In general, it is advisable to avoid using unshielded wires.

If a shielded wire is used, connect one end of the ground wire to the ground terminal of the oscilloscope, and the other to the ground terminal of the circuit being measured. It is desirable to use a BNC-type, coaxial cable as the input wire.

- If the waveform being observed has a fast rise time or is high frequency, it is necessary to connect a termination resistance of 50Ω to the scope end of the cable. If the cable is particularly long, a termination resistance of 50Ω must be connected, depending on the circuit being measured, to the scope end of the cable.

It is more convenient if a BNC-type, termination resistor (50Ω) is used.

- In some cases, the circuit under test may require a 50Ω termination proper operation before measurements may be taken.

- If a long shielded wire is used for taking measurements, the stray capacitance must be considered: Shielded wire in general has approximately 100pF capacitance per meter, the effects on the circuit being measured cannot be ignored, the use of probes will minimize the effects on the circuits being measured.

- A shielded cable with no termination resistance, whose length is a $1/4$ wavelength or a multiple of a $1/4$ wavelength of a frequency within the 6500 series bandwidth (60MHz , 40MHz or 20MHz) may cause an oscillation on the $5\text{mV}/\text{Div}$ range. To prevent this, connect a 100Ω to $1\text{k}\Omega$ resistor in series with the cable, thereby lowering the Q of this circuit or use a higher Volts/Div range.

8. Measuring Procedures

Perform the following steps.

- Set brightness and focus to the settings that will give the best display
- Display wave forms as large as possible, to minimize time errors.
- If probes are being used, verify capacitance compensation (Refer to section (1) [when probes are being used], paragraph 6: Signal Connections for capacitance compensation methods).

8-1. Measuring DC voltage

Set the AC-GND-DC switch to GND, and position the zero level to convenient position on the screen. This position need not necessarily be the center of the screen.

Set Volts/Div to an appropriate setting, then set the AC-GND-OC switch to DC. The trace which is a straight line will deflect. The DC voltage can be obtained by multiplying the amount of Divisions the line deflects by the Volts/Div value. For example, in the case of Fig. A, if Volts/Div is 50mV/Div, the calculation is $50\text{mV/Div} \times 4.2 = 210\text{mV}$ (However, if probe (10:1) is used, the actual signal value is found by multiplying by 10; hence, $50\text{mV/Div} \times 4.2 \times 10 = 2,100\text{mV} = 2.1\text{V}$)

8-2. Measuring of AC voltage

As for measuring DC voltage. Set the zero level to any place on the CRT where it is convenient.

In the case of Fig. B, if Volts/Div is 1V/Div, the calculation is $1\text{V/Div} \times 5 = 5\text{Vp-p}$ (However, if a probe (10:1) is used, the actual value is 50Vp-p).

If a small amplitude AC signal is superimposed on an large DC voltage the AC component maybe viewed and expanded by setting the AC-DC-GND switch to AC, this will block the DC portion of the signal and pass the AC portion only.

8-3. Frequency and time measurement

Use Fig. C for the example, 1-cycle is from point A to B, and is 2.0Divs on the screen. If the sweep time is assumed to be 1 ms/Div, the period $1\text{ms/Div} \times 2.0 = 2.0\text{ms}$. Accordingly, the frequency is $1/2.0\text{ms} = 500\text{Hz}$.

However, if $\times 10\text{MAG}$ ($\times 5\text{MAG}$) is used, the time/Div must be calculated as $1/10$ ($1/5$) of the indicated value!

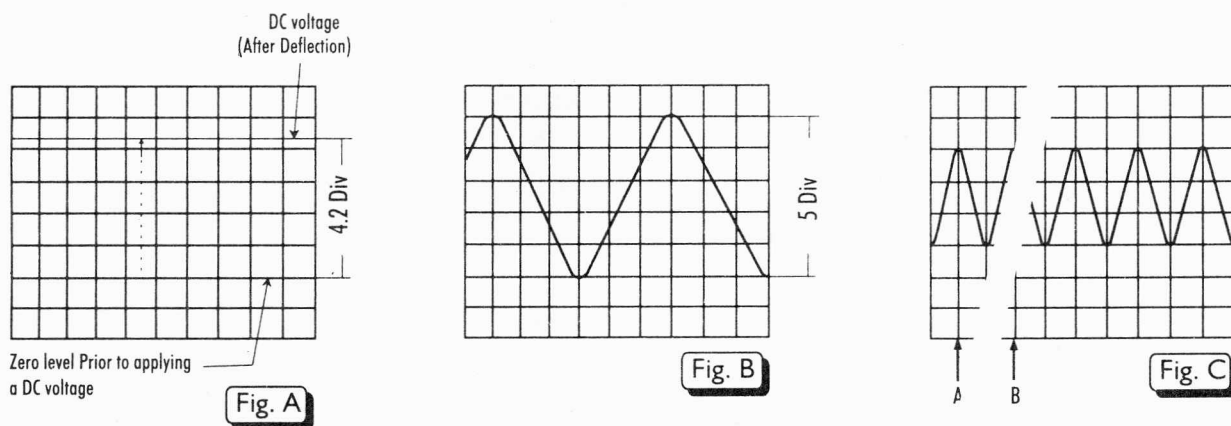

8-4. Time difference measurement

Set the signal which is the reference for the 2 signals being observed as the trigger signal. (Refer to Fig D).

A If the signals are as in Fig. D(a), Fig. D(b) will be displayed when the trigger signal source is set to CH 1.

B Fig D(c) will be displayed when the trigger signal source is set to CH2.

In order to measure the time delay between to signals use the following procedure:

A To find the time CH 2 is delayed in respect to CH 1 set the trigger signal source to Int.

B To find the time CH 1 is delayed in respect to CH 2 set the trigger signal source to CH 2.

C The delay time maybe found by counting the number of Divisions from the rising edge of the trigger source signal to the rising edge of the delayed signal and multiplying this by the Time/Div setting.

In order to measure time delay, set the signal with the leading phase as the trigger signal, If the reverse condition exists (the delayed signal triggers the oscilloscope) the desired portion of the waveform to be observed may not be displayed on the CRT screens. In this case overlap the signal amplitudes with the vertical position controls.

The delay time is measured between the 50% amplitude of the displayed signals.

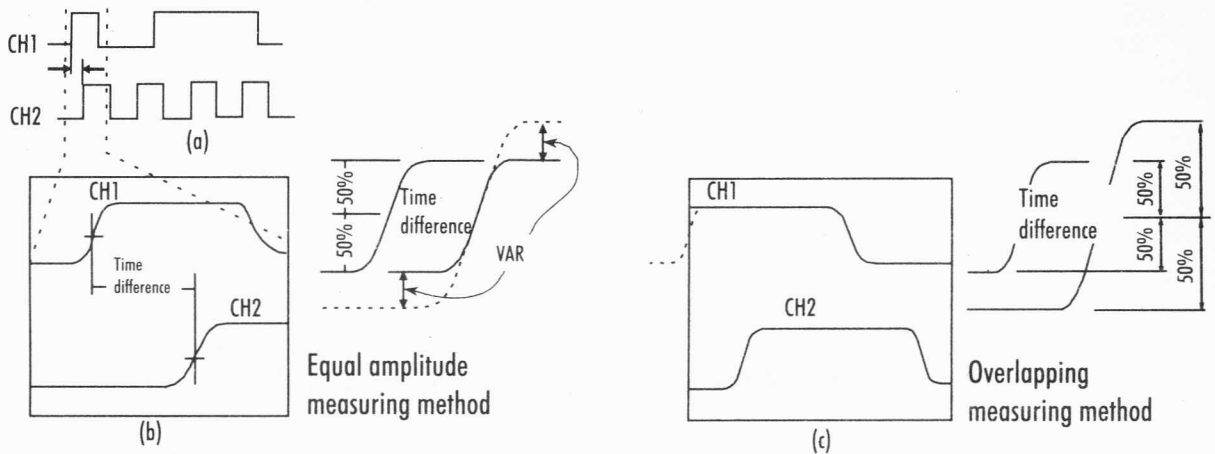

Fig. D

1) Caution

A pulse wave contains a considerable number of high-frequency components (harmonic waves), use the same procedures as for measuring high frequency signals. Use probes or coaxial cable, and make the grounding line as short as possible.

8-5. Measuring rise (fall) time

When pulse rise time is being measured, use the precautions detailed in the preceding section, and observe measurement errors. The following relationships exist between the rise time Tr_x of the wave form being measured, the rise time $firs$ of the oscilloscope and the rise time Tro displayed on screen.

$$Tro = \sqrt{Tr_x^2 + Tr_s^2}$$

If the rise time of the pulse to be measured is significantly greater than that of the oscilloscope, measurement errors occurring with respect to oscilloscope rise time can be disregarded. If the rise times are too close to each other, measurement errors will occur.

Actual rise time is then $Tr_x = \sqrt{Tro^2 - Tr_s^2}$

In addition, for circuits where there are no wave form distortions, such as overshoot or sag, in general, the following relationship exists between the frequency band width and rise time.

$$fc \times tr = 0.35$$

Where: fc : Frequency band (Hz)
 tr : rise time (s)

8-6. Complex wave form synchronization

As shown on Fig. E (a), if the difference in amplitudes appears alternately, wave forms may appear overlapped, depending on the trigger level setting.

If the trigger level selected is the line A,B,C, D,E,F····· which starts from A····· and the line E,F,G, H, I..which starts from E····· appear alternately, the trace will appear overlapped as shown in Fig. E (b), synchronization cannot be achieved. If, the trigger level is turned clockwise to set trigger level to the Y'-line, the wave form displayed on screen is shown in Fig. E (c), allowing synchronization to be achieved.

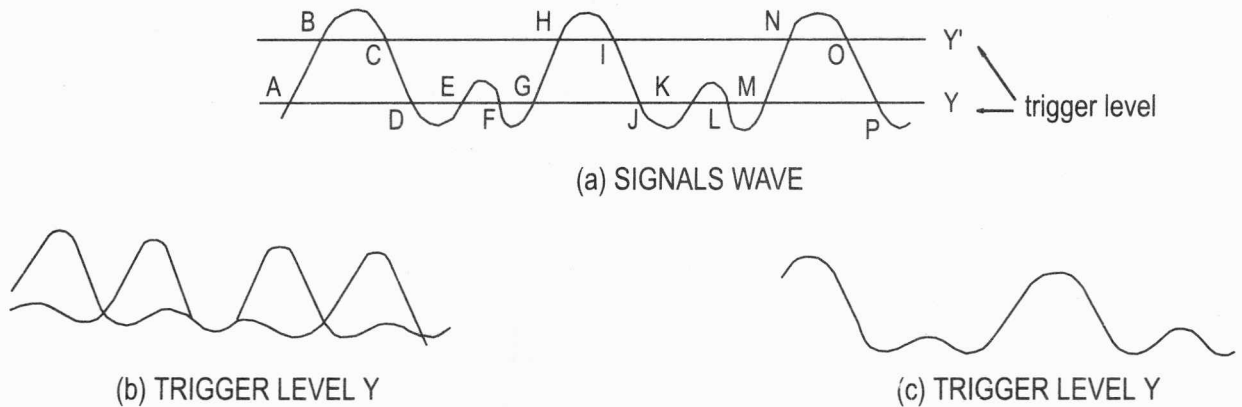

Fig. E

8-7. Wave forms when 2 channels are being measured

1) If CH1 and CH2 signals have a synchronized interrelationship, or 2 signal frequencies have a specific time relationship, such as a constant proportion, set the TRIG signal source switch to INT. If the CH2 time is being checked relative to CH1 signal; set trigger source to CH1 if vice versa, set the trigger source to CH2.

2) If 2 signals having no synchronized relationship are being observed, set TRIG signal source switch to INT. The trigger signal will alternate whenever the displayed waveform alternates. The waveform on each channel will appear stable.

As shown in diagram No. 1, if a sine wave is input to CH1 and a rectangular wave to CH2, the triggerable level range is A.

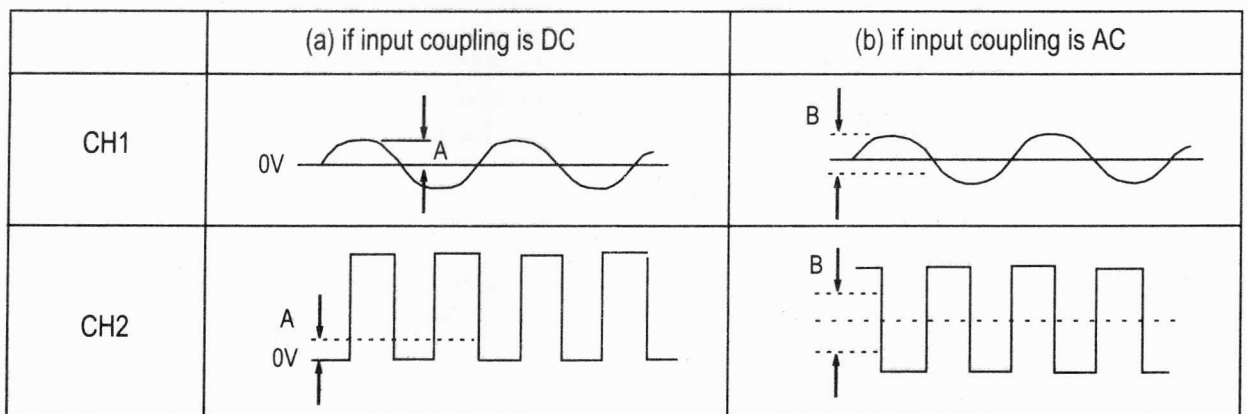

Diagram No. 1

To magnify the synchronizing level range, the CH2 axis input coupling may be set to AC coupling. In addition, as shown in Diagram No. 2, if any one of the signals display selector is small, set the amplitude to a sufficient level by changing the Volts/Div selectors switch 21) 32).

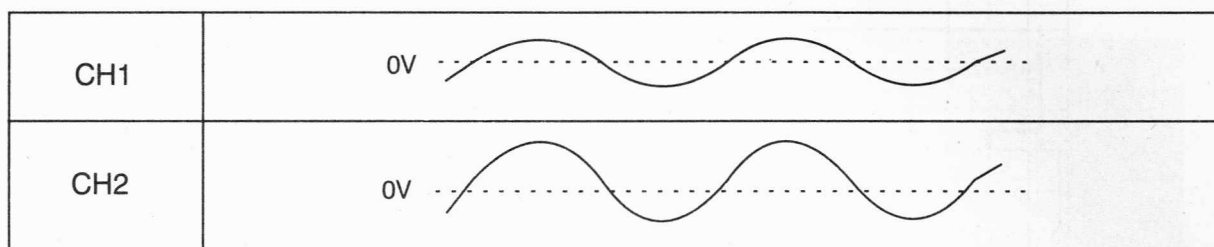
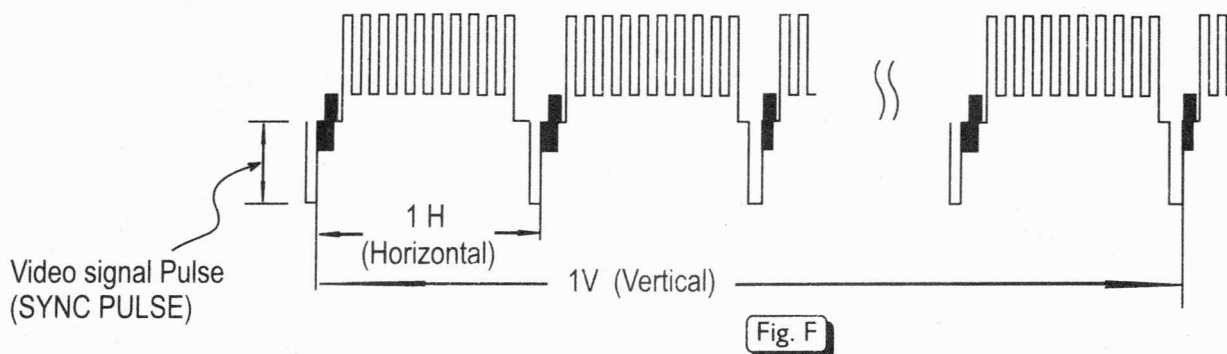

Diagram No. 2

8-8. TV-exclusive synchronization

1) The TV wave form

In TV mode, complex signals containing the video signal, blanking pedestal signal and synchronizing signal displayed in Fig. F are clearly observed. However, because the wave form is complex, a special circuit is required to link synchronization to the vertical synchronizing signal



2) Differences between competitor oscilloscope and this oscilloscope with respect to circuitry is.

In order to ensure stabilized measurement of TV signals, this oscilloscope is equipped with a TV-exclusive synchronizing separator circuit, as shown in the drawing.

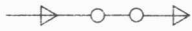
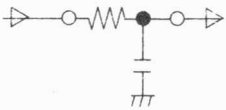
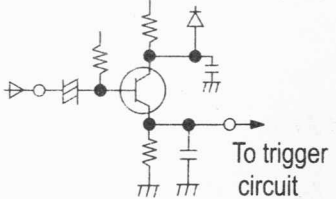
	Exclusive circuitry of conventional equipment		Operating circuitry of this equipment
	General circuitry	Simple integrator circuitry	Exclusive TV synchronizing separator circuitry
circuit	circuitry to video signal trigger circuit 	To trigger circuit 	
Features	Because the video signal is directly applied as the trigger signal, synchronizing is difficult.	Because signals are integrated to remove harmonic wave components, synchronizing is accomplished more easily than in left diagram	The vertical synchronizing signal is separated after the synchronizing pulse is extracted, stable synchronization is obtained.

3) Operation

Vertical sync is displayed

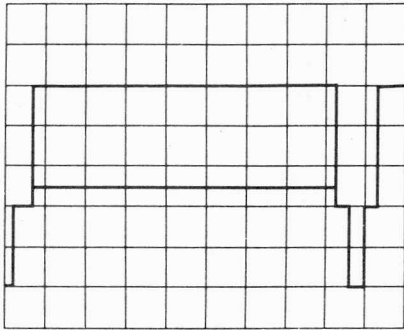

Fig. G

MODE : TV-V
 TIME/Div
 0.1ms/Div~0.2s/Div

Horizontal sync is displayed

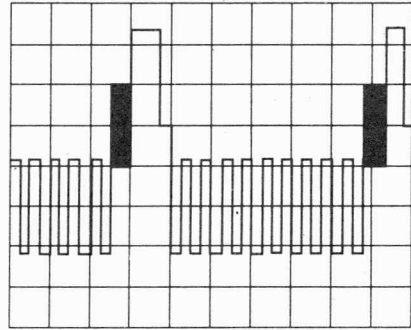

Fig. H

MODE : TV-H
 TIME/Div
 50 μ s/Div~0.05 μ s/Div

[Note] If the oscilloscope is in the TV mode, the trigger level control is not used.
 This oscilloscope synchronizes only on (-) synchronizing signal.

[Reference]

A : Sample (-) synchronizing signal

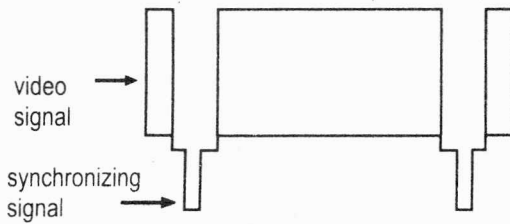

A

B : Sample (+) synchronizing signal

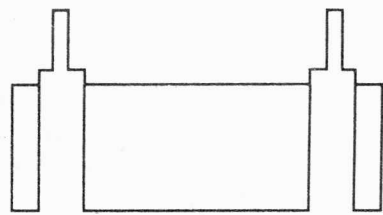

B

Fig. I

9. Specifications

9-1. Vertical axis

	20MHz	40MHz	60MHz	REMARKS
CH1 AND CH2 SENSITIVITY	5mV/Div to 5V/Div 1-2-5 step, 10 calibrated steps (1mV/Div to 1V/Div at x5 MAG)			
Accuracy	± 3% } +10°C to +35°C ± 5% (at x5 MAG)			Vertical knob is set to CAL position
Variable vertical sensitivity	To less than 1/2.5 times indicated sensitivity value			
Frequency band width x5 MAG	DC : DC to 20MHz AC : 10Hz to 20MHz	DC : DC to 40MHz AC : 10Hz to 40MHz	DC : DC to 60MHz AC : 10Hz to 60MHz	
	DC : DC to 7MHz AC : 10Hz to 7MHz	DC : DC to 7MHz AC : 10Hz to 7MHz	DC : DC to 7MHz AC : 10Hz to 7MHz	
Rise time	Approximately 17.5ns	Approximately 8.7ns	Approximately 5.8ns	
Input impedance	1MΩ ± 2%, 25pF ± 3pF			
Maximum input voltage	300V(DC+AC peak)			
Input coupling system	AC-GND-DC			
Operating systems	CH1 : Only Channel 1 operates CH2 : Only Channel 2 operates ADD : Algebraic sum of 2 signals (CH1 + CH2) DUAL : Channels 1 and 2 simultaneously displayed			
Invert	Only CH2 signal is inverted			
Overshoot	Maximum 8%			

9-2. CH1 Input Amplifier

	20MHz	40MHz	60MHz	REMARKS
Output volatge	Minimum 20mV/Div			
Output impedance	Approximately 50Ω			
Bandwidth	50Hz to 5MHz (-3dB)			

9-3. TIME AXIS

	20MHz	40MHz	60MHz	REMARKS
Sweep mode	A,XY,ALT,MAG, x5MAG	A,XY,ALT,MAG, x10MAG		
Sweep time	0.1 μs to 0.2s/Div ± 3%, in 20calibrated steps (1-2-5 Seq)			
Sweep expansion	20ns/Div to 40ms/Div (20ns/Div,40ns/Div : uncal)	10ns/Div to 20ms/Div (10ns/Div : Uncal)		
Alt. MAG TRACE	Maximum 4 traces			
Trace Sep. Var	Minimum 1.5 Div			

9-4. Triggering

		20MHz	40MHz	60MHz					
Trigger mode		AUTO, NORM, TV-V, TV-H							
Trigger signal source		INT, CH2, LINE, EXT							
Polarity		+, -							
Coupling system		AC coupling							
Sensitivity									
	Frequency	INT	EXT	Frequency	INT	EXT	Frequency	INT	EXT
NORM	DC to 2MHz	3Div	200mV	DC to 5MHz	3Div	200mV	DC to 5MHz	3Div	200mV
	2MHz to 20MHz	3Div	200mV	5MHz to 40MHz	3Div	800mV	5MHz to 40MHz	3Div	800mV
AUTO	20Hz to 2MHz	3Div	200mV	20Hz to 5MHz	3Div	200mV	20Hz to 5MHz	3Div	200mV
	2MHz to 20MHz	3Div	300mV	5MHz to 40MHz	3Div	800mV	5MHz to 40MHz	3Div	800mV
TV synchronization		INT	Minimum 1 Div						
		EXT	Minimum 1 Vp-p						

9-5. XY OPERATION

		20MHz	40MHz	60MHz	REMARKS
Operating mode		CH1, X-axis and CH2, Y-axis; When in X-Y operation mode			
Sensitivity		As vertical axis			
Input impedance		1M Ω 2% approximately 25pF			
X-axis bandwidth		DC-500kHz			
Phase difference		Maximum 3 $^{\circ}$ (DC-50kHz)			

9-6. Z axis

		20MHz	40MHz	60MHz	REMARKS
Input impedance		33k Ω			
Maximum input voltage		30V (DC + AC peak), MAX AC 1kHz			
Bandwidth		DC to 2MHz			
Input signal		$\pm 5V$ (Negative increases intensity)			

9-7. CAL

		20MHz	40MHz	60MHz	REMARKS
Frequency		1kHz (20%)			
Output level		0.5V ($\pm 3\%$)			
Duty		Minimum 48:52			

9-8. Power supply

	20MHz	40MHz	60MHz	REMARKS
Voltage	AC 100V/120V/220V/230V ±10%			
Frequency	50Hz to 60Hz			
Power consumption	35W	35W	55W	

9-9. CRT

	20MHz	40MHz	60MHz	REMARKS
Type	6inch square internal scale			
Acceleration voltage	-1.9kV	12K	12K	
Effective screen	8Div(vertical direction)X10Div(horizontal direction)			

9-10. Environmental conditions

	20MHz	40MHz	60MHz	REMARKS
Operating temperature	0 °C to 40 °C			
Operating humidity	35% to 85%			
Guaranteed operating temperature	10 °C to 35 °C			
Guaranteed operating humidity	45% to 85%			
Guaranteed operating temperature	-20 °C to 70 °C			
Guaranteed operating humidity	35% to 85% (Less than 70% at temperatures exceeding 50 °C)			

9-11. Mechanical specifications

	20MHz/40MHz/60MHz			REMARKS
Physical dimensions	Height	Width	Length	
	140 (H)	335 (W)	375 (D)	
Weight	Approximately 7.3kg			

10. Maintenance, Repair and Storage

- (1) This equipment is composed of many high-precision components and components which require high internal pressure, care is required when handling or storing this equipment.
- (2) Occasionally, clean the graticule scale with a clean, soft cloth.
- (3) Ideal ambient temperature range when storing this equipment is -10°C to $+60^{\circ}\text{C}$

Calibration Period

In order to maintain this equipment in stable and efficient operating condition, calibrate the equipment after every 1,000 hours operating time, or every 6 months; whichever is shorter.

11. External Drawing

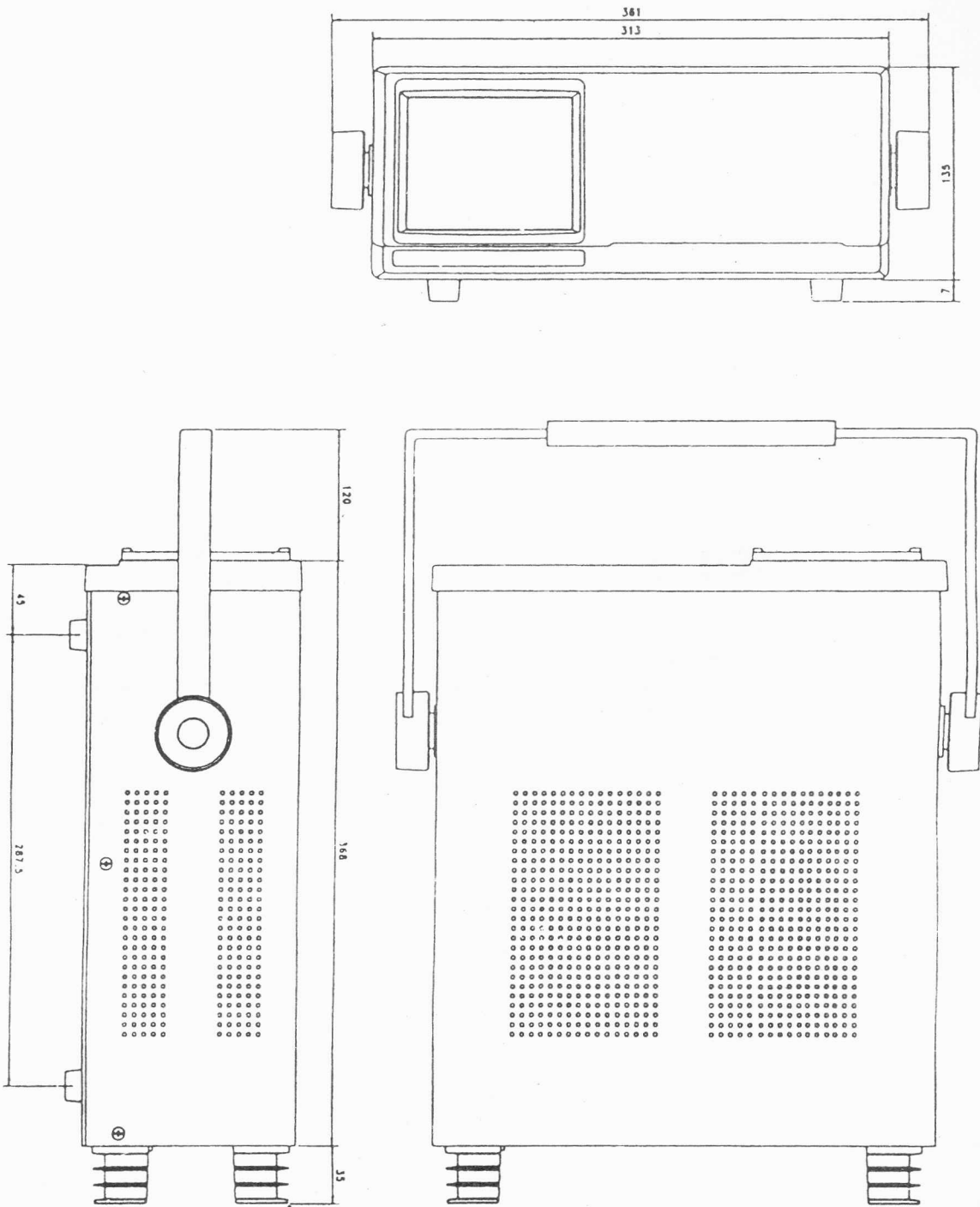

11-1 60MHz, 40MHz, 20MHz External drawing