

# ΕΙΣΑΓΩΓΗ ΣΤΑ ΤΗΛΕΠΙΚΟΙΝΩΝΙΑΚΑ ΣΥΣΤΗΜΑΤΑ

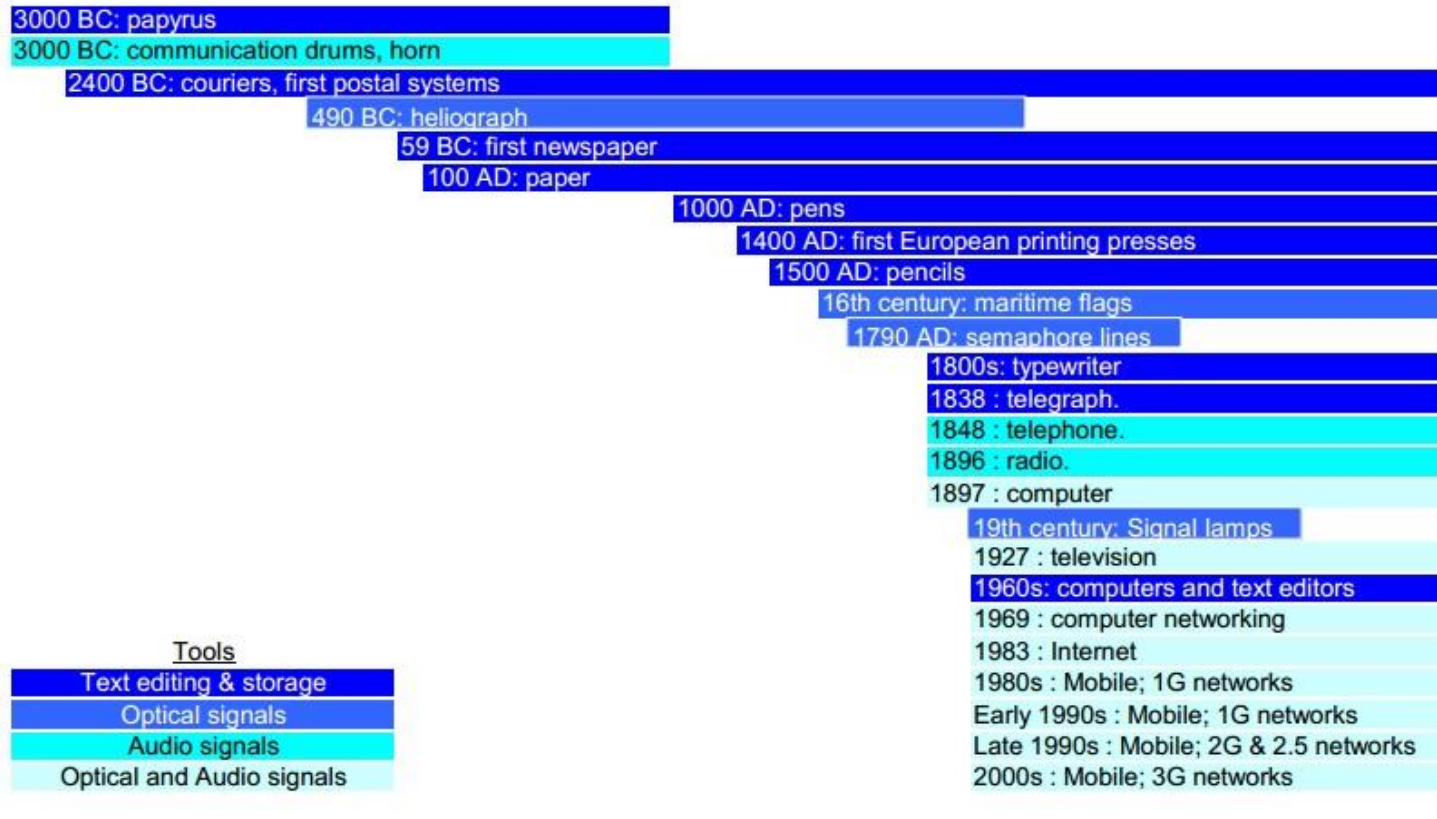

# Timeline of Communication tools



**Tools**

- Text editing & storage
- Optical signals
- Audio signals
- Optical and Audio signals

Communication tools from the BC era. Only the postal system and newspapers are still in use today.

Communication tools during the 1900 years AD. Almost all of these tools are still in use today. They have been improved over time, and merged with later tools and technologies.

The early days of computer, networking, and internet.

The era of Telecommunication

Paul Allen



**Microsoft**

**1970**

Intel introduces the world's first available dynamic RAM chip and the first microprocessor, the Intel 4004



**1976**

Apple Computers founded by Steve Wozniak and Steve Jobs



**1977**

The Apple II, the first personal computer with colour graphics, is demonstrated



**1979**

Over half a million computers are in use in the United States

**1982**

The Commodore 64 becomes the best-selling computer of all time



**1985**

The Nintendo Entertainment System makes its debut



**1991**

The World Wide Web is launched to the public on August 6, 1991

**2004**

Facebook launched



**2002**

Approximately 1 billion PCs sold to date



**1998**

Google founded by Sergey Brin and Larry Page



**2006**

Twitter launched



**2010**

Apple launches the first iPad



**2012**

Google Chrome has 28% worldwide usage share of web browsers



# A Modern History of Human Communication

▲ AVERAGE INTERNATIONAL CALL COST PER MINUTE  
(extrapolated & inflation adjusted \$)

▲ % OF WORLD USING  
 ▲ CELL PHONES ▲ INTERNET ▲ LANDLINES

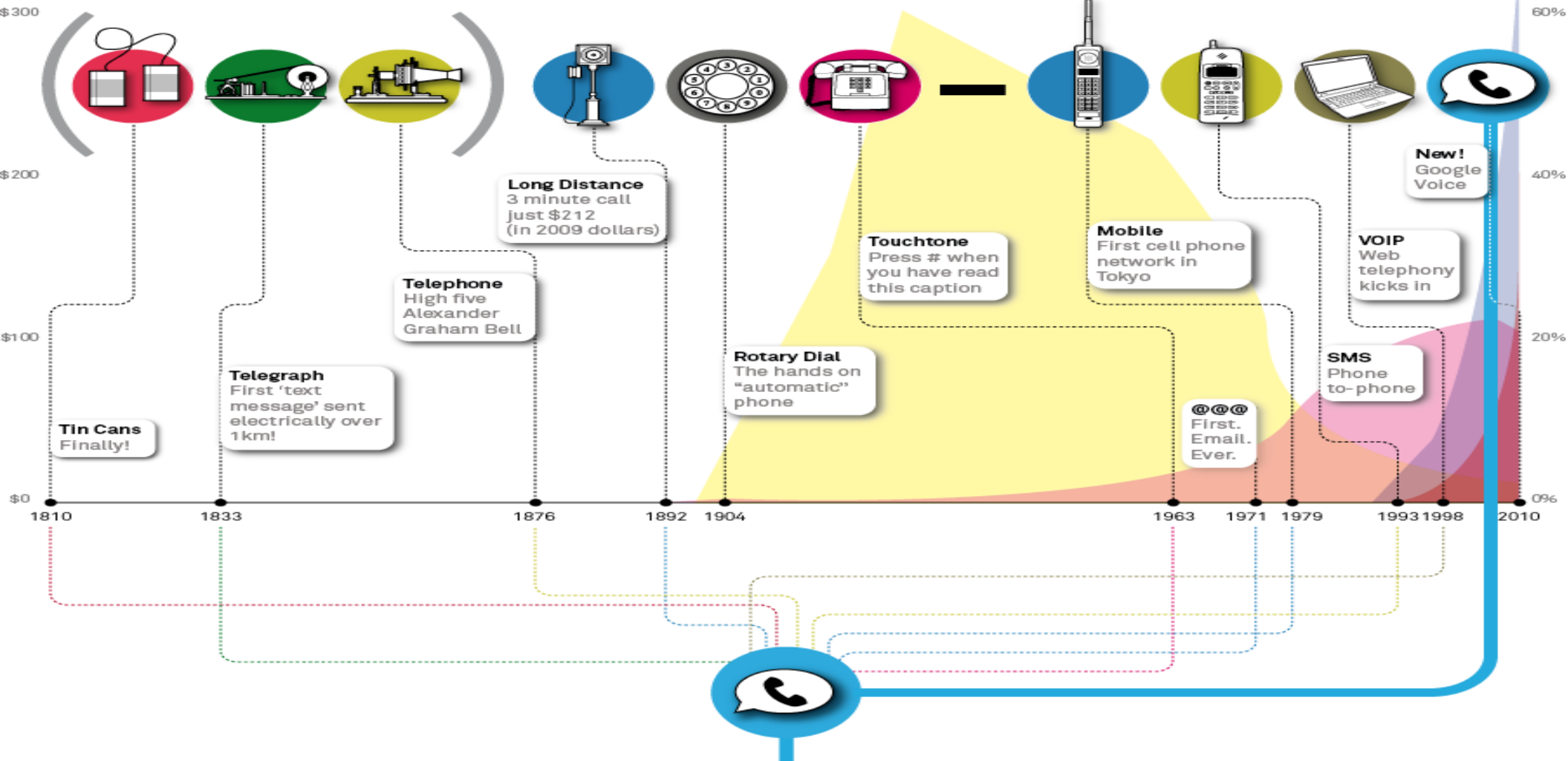

## Google Voice



Voice mail transcription



One number rings all your phones



Block callers with one click



Insanely cheap international calls



Forward SMS to your email



Personalized greetings



Set up free conference calls

# ΙΣΤΟΡΙΚΗ ΑΝΑΣΚΟΠΗΣΗ

“λίθινη – αρχαία” εποχή



# ΙΣΤΟΡΙΚΗ ΑΝΑΣΚΟΠΗΣΗ

“λίθινη – αρχαία” εποχή

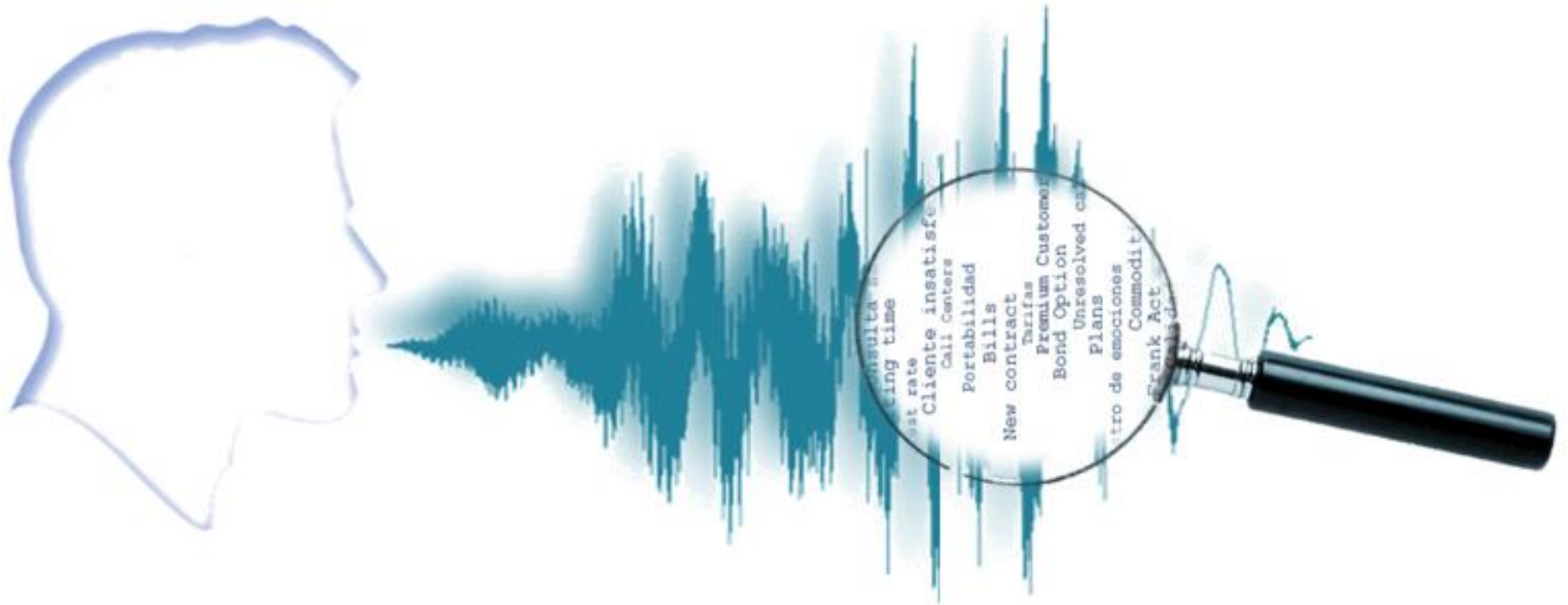

συριγμοί, μίμηση ζώων, μίμηση πτηνών, κραυγές, φωνές, φωνήματα, ομιλία

# ΙΣΤΟΡΙΚΗ ΑΝΑΣΚΟΠΗΣΗ

## “λίθινη – αρχαία” εποχή

Γραφή: Επανάσταση στις  
επικοινωνίες.

Εμφάνιση κρυπτογραφίας -  
στεγανογραφίας

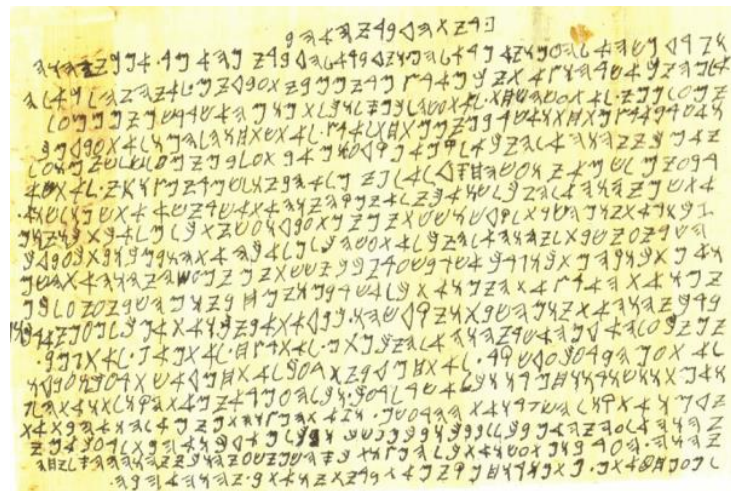
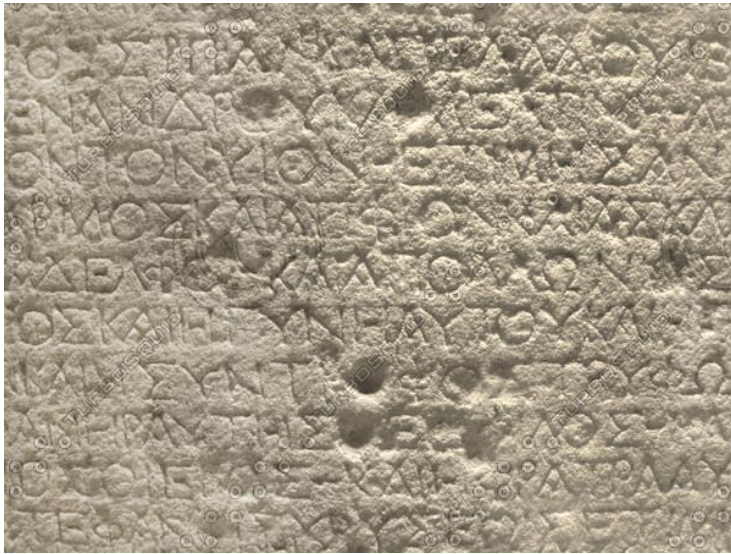

# ΙΣΤΟΡΙΚΗ ΑΝΑΣΚΟΠΗΣΗ

## αρχαιότητα

Φρυκτωρίες: Επανάσταση στις Τηλεπικοινωνίες.



	1	2	3	4	5		
1							Α Β Γ Δ Ε
2							Ζ Η Θ Ι Κ
3							Λ Μ Ν Ξ Ο
4							Π Ρ Σ Τ Υ
5							Φ Χ Ψ Ω ?
							11 12 13 14 15
							21 22 23 24 25
							31 32 33 34 35
							41 42 43 44 45
							51 52 53 54 55
							15 41 11 32 15 24 33 54 33 14 11 43 ΕΠΑΜΕΙΝΩΝΑΣ



# ΙΣΤΟΡΙΚΗ ΑΝΑΣΚΟΠΗΣΗ

## Αρχαιότητα

Ταχυδρομικά Περιστερία: Επανάσταση  
στις Τηλεπικοινωνίες.

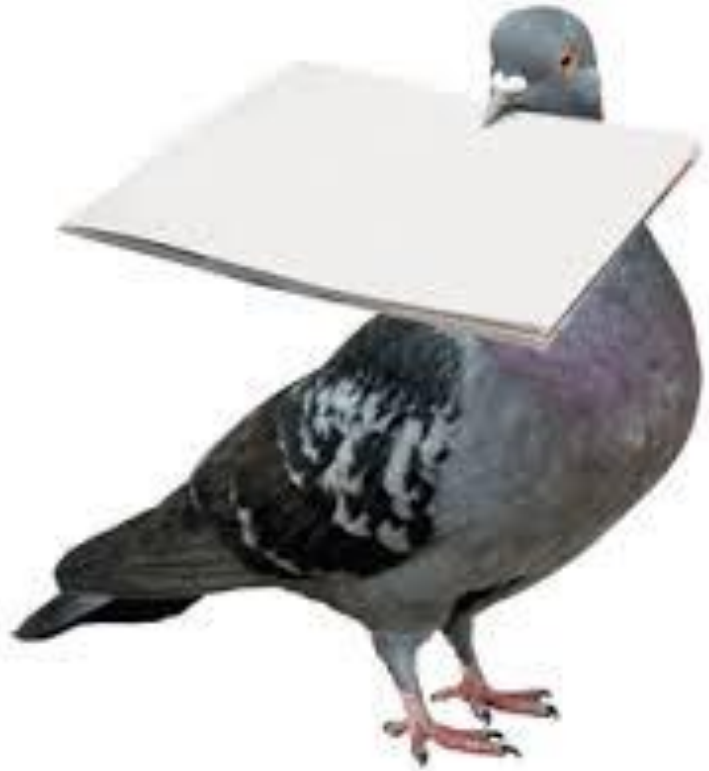

# ΙΣΤΟΡΙΚΗ ΑΝΑΣΚΟΠΗΣΗ

## Μεσαίωνας

Τυπογραφία στην Ευρώπη: Επανάσταση στις επικοινωνίες. Πρώτη προτυποποίηση



www.shutterstock.com · 538891594



# ΙΣΤΟΡΙΚΗ ΑΝΑΣΚΟΠΗΣΗ Μεσαίωνα

Σηματωροί

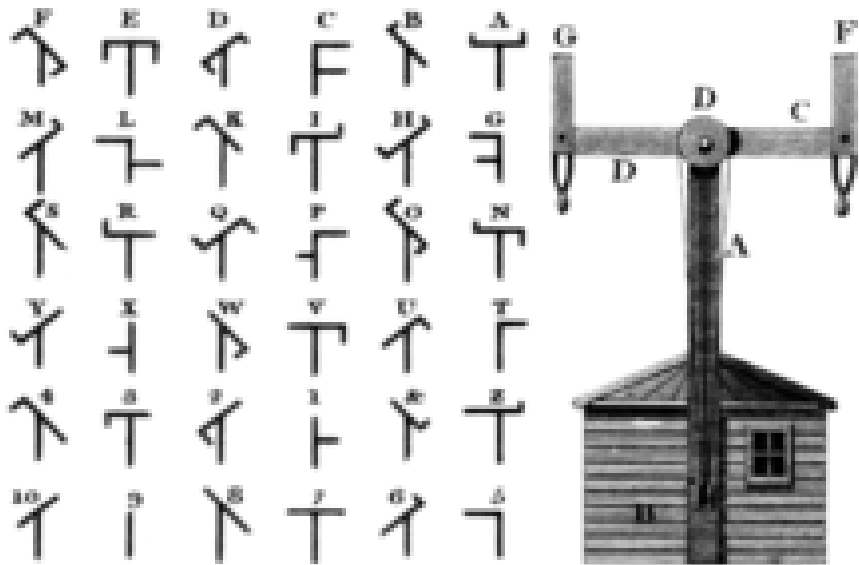

# ΙΣΤΟΡΙΚΗ ΑΝΑΣΚΟΠΗΣΗ 18<sup>ος</sup> - 19<sup>ος</sup> αιώνας



Εφημερίδες



Τηλέγραφος



Τηλέφωνο

# ΙΣΤΟΡΙΚΗ ΑΝΑΣΚΟΠΗΣΗ 19ος αιώνας – αρχές 20<sup>ου</sup>



Photo: Cassell & Co., Ltd

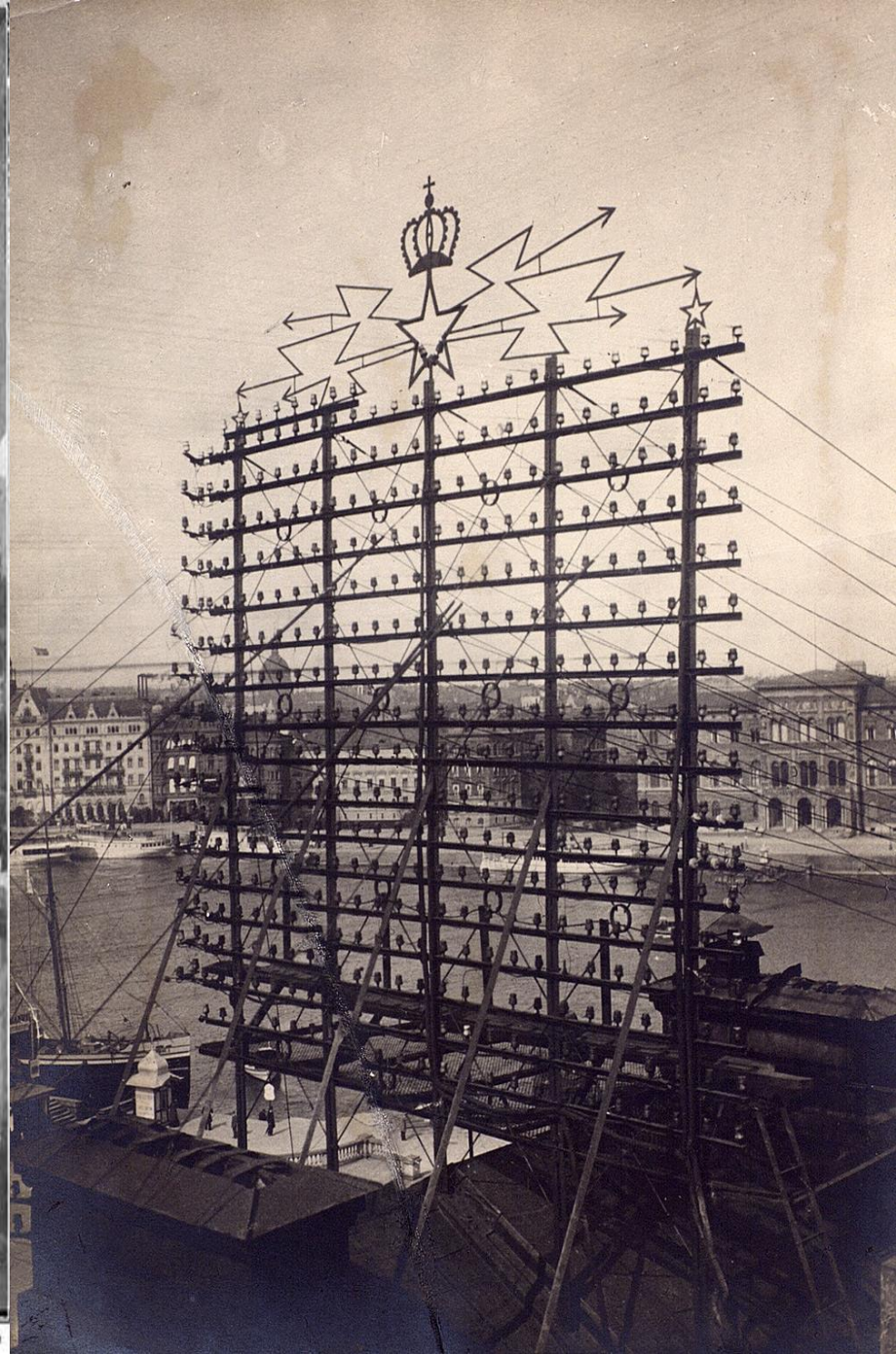

# A Modern History of Human Communication

▲ AVERAGE INTERNATIONAL CALL COST PER MINUTE  
(extrapolated & inflation adjusted \$)

▲ % OF WORLD USING  
▲ CELL PHONES ▲ INTERNET ▲ LANDLINES

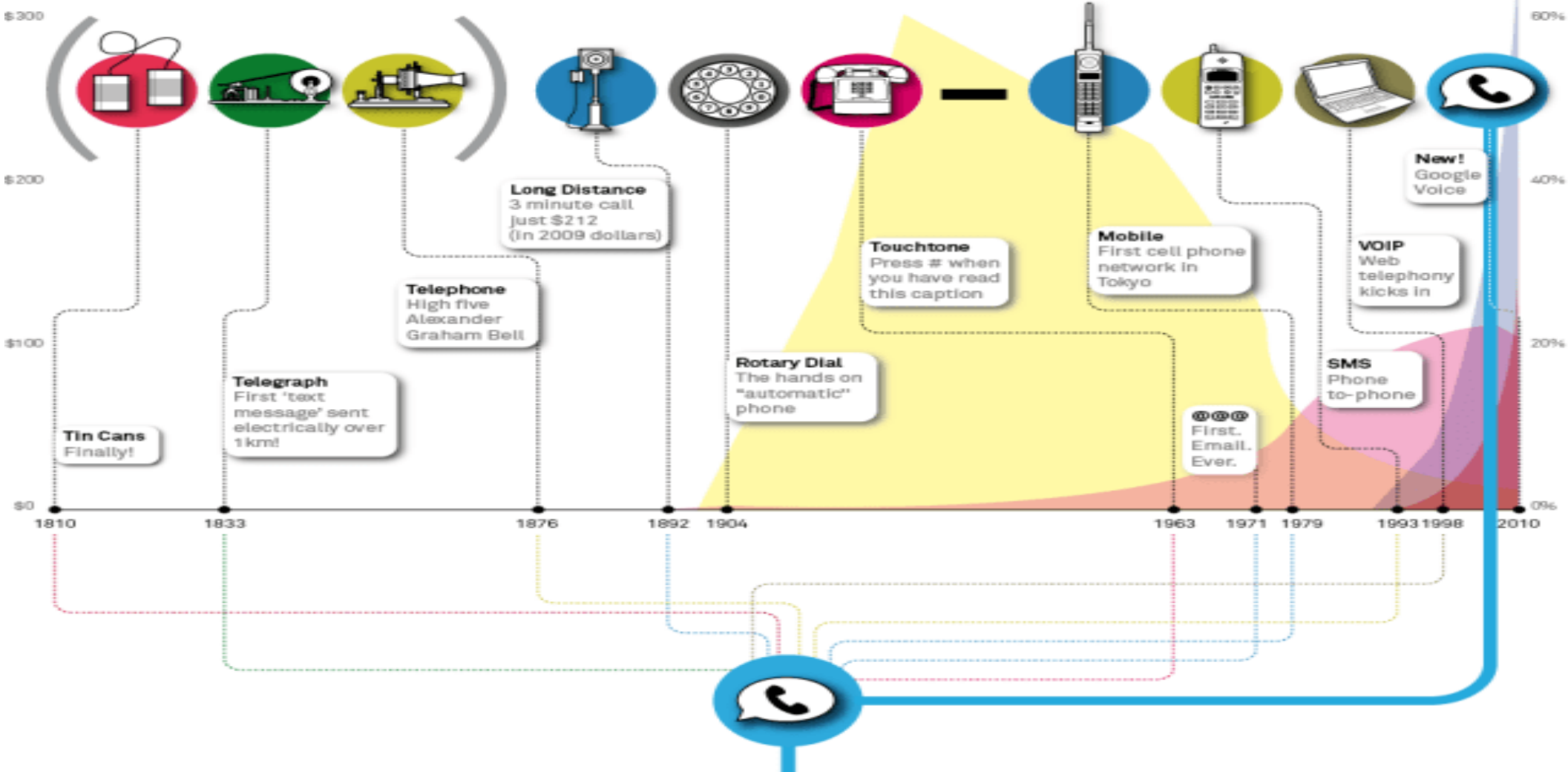

## Google Voice



Vocemall transcription



One number rings all your phones



Block callers with one click



Insanely cheap international calls



Forward SMS to your email



Personalized greetings



Set up free conference calls

# Κινητή τηλεφωνία

## Structure of a GSM network

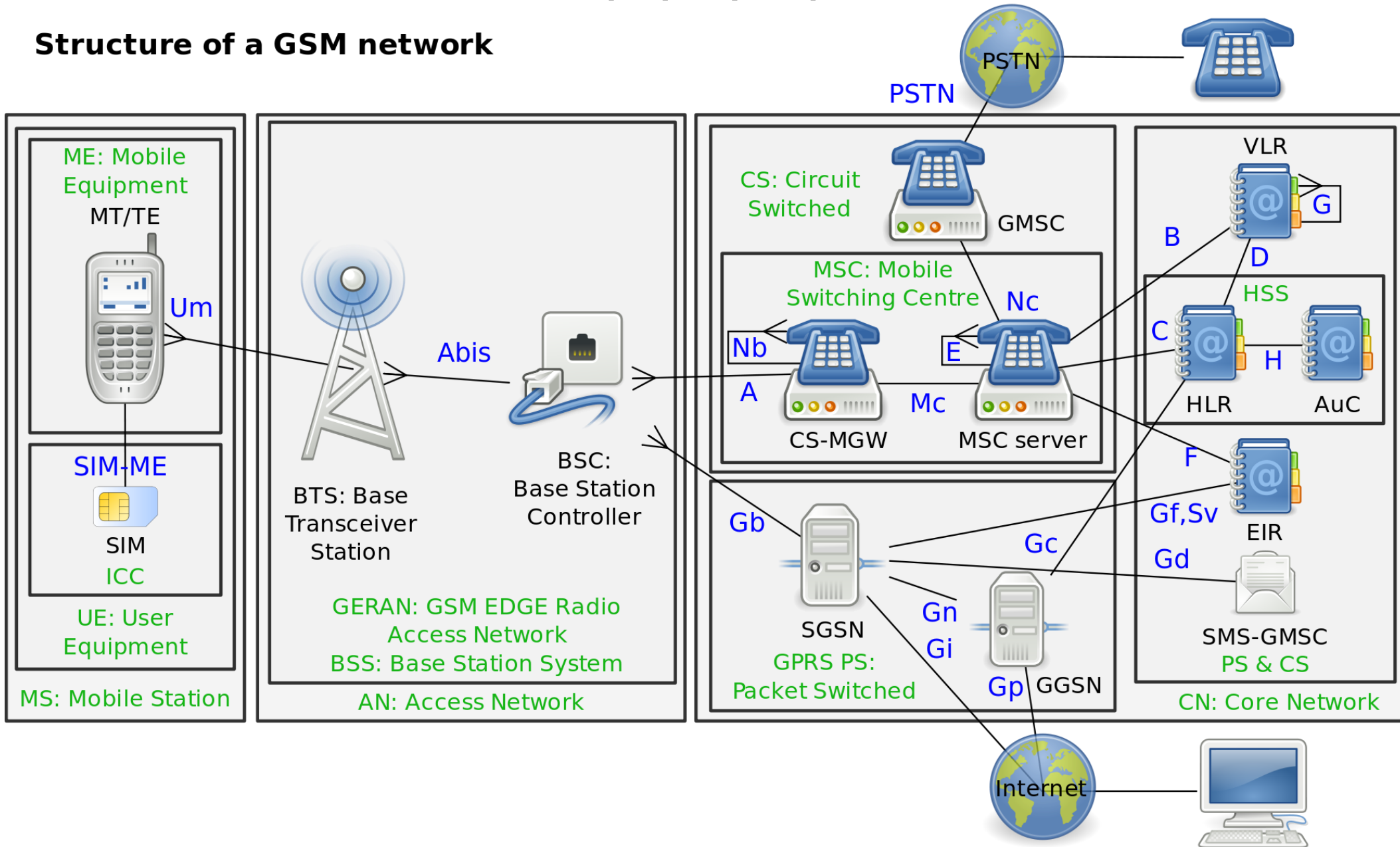

# THE INTERNET TIMELINE

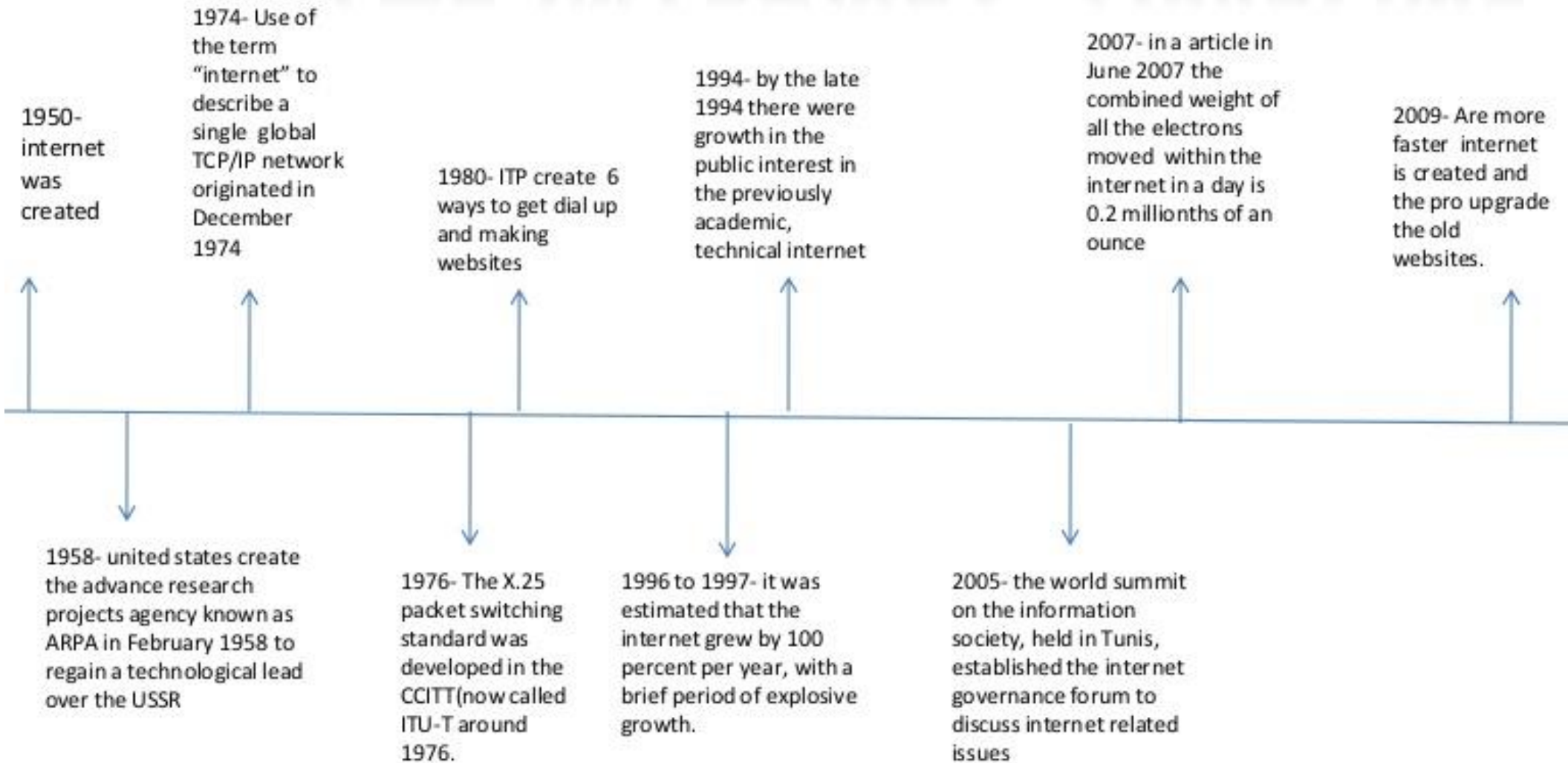



# ΤΗΛΕΠΙΚΟΙΝΩΝΙΑΚΑ ΣΥΣΤΗΜΑΤΑ

Ενσύρματες  
Επικοινωνίες

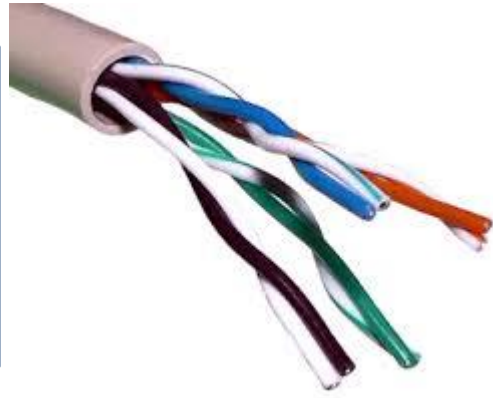

Ασύρματες  
Επικοινωνίες

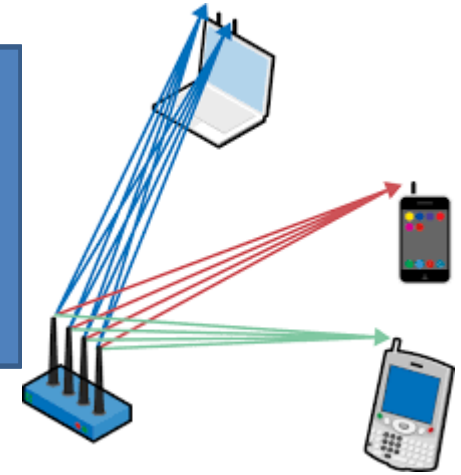

Οπτικές Ίνες



Δορυφορικές  
Επικοινωνίες



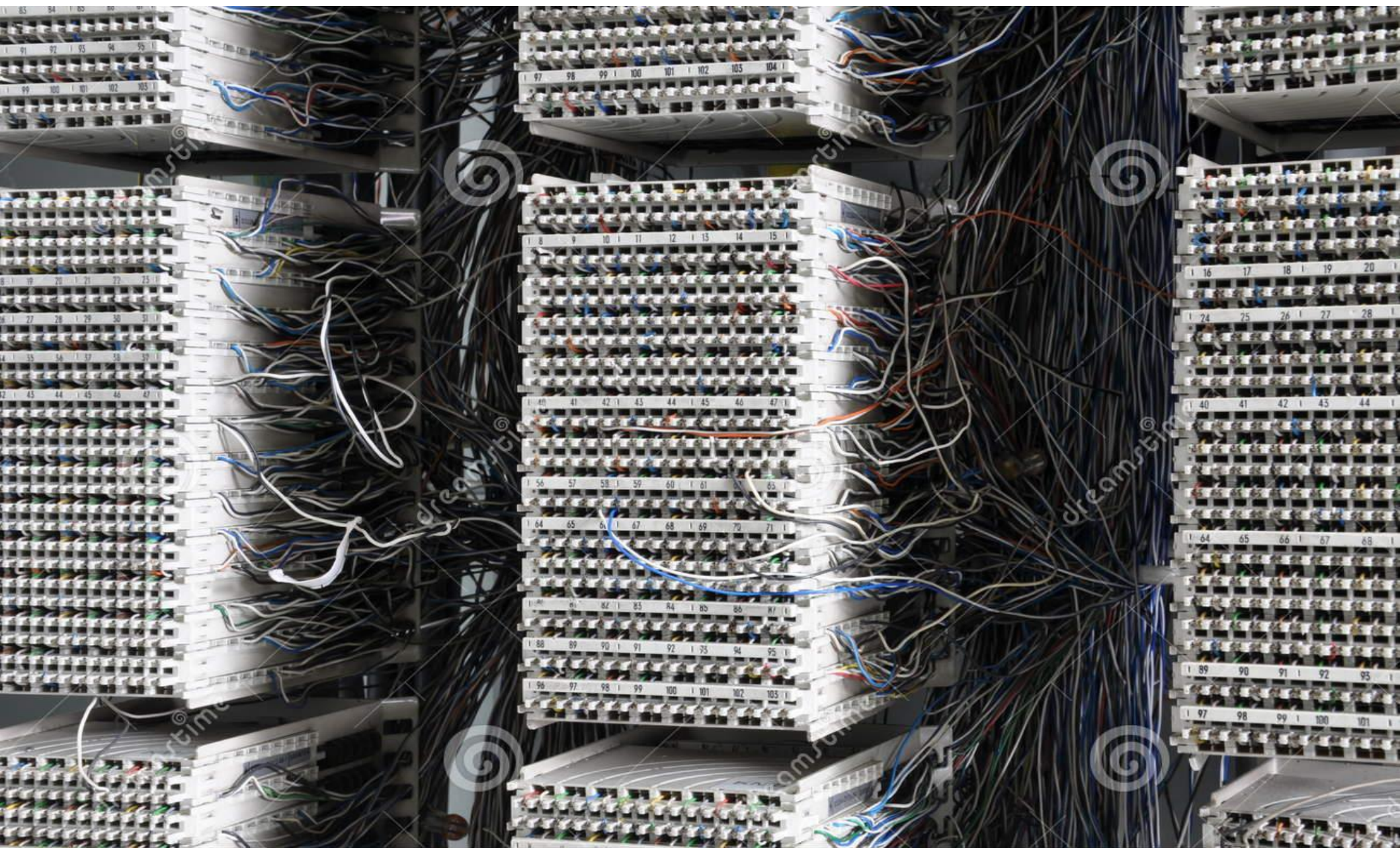

Download from  
**Dreamstime.com**

This watermarked comp image is for previewing purposes only.



ID 50646297

© Minaret2010 | Dreamstime.com



# Global Observing System

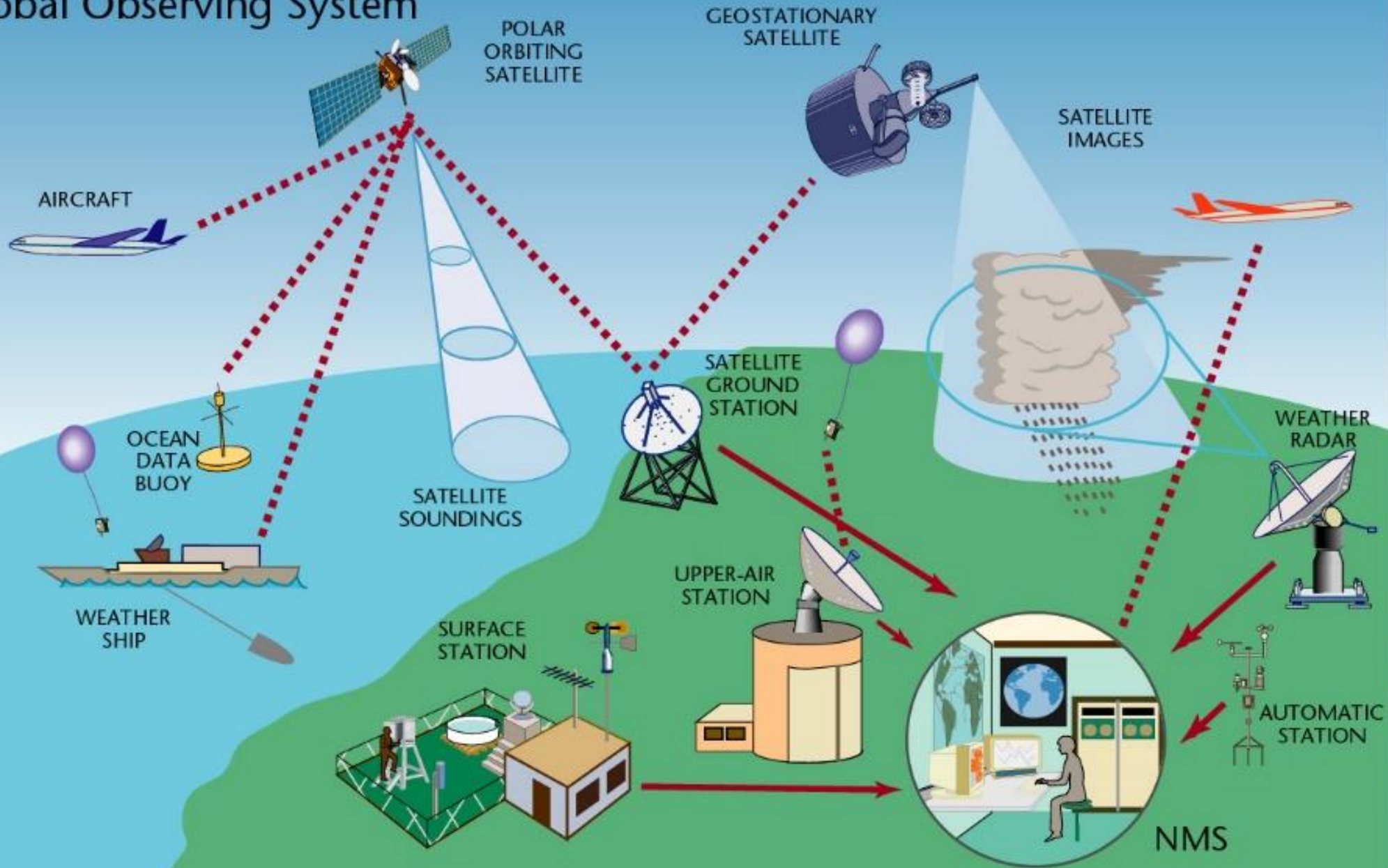



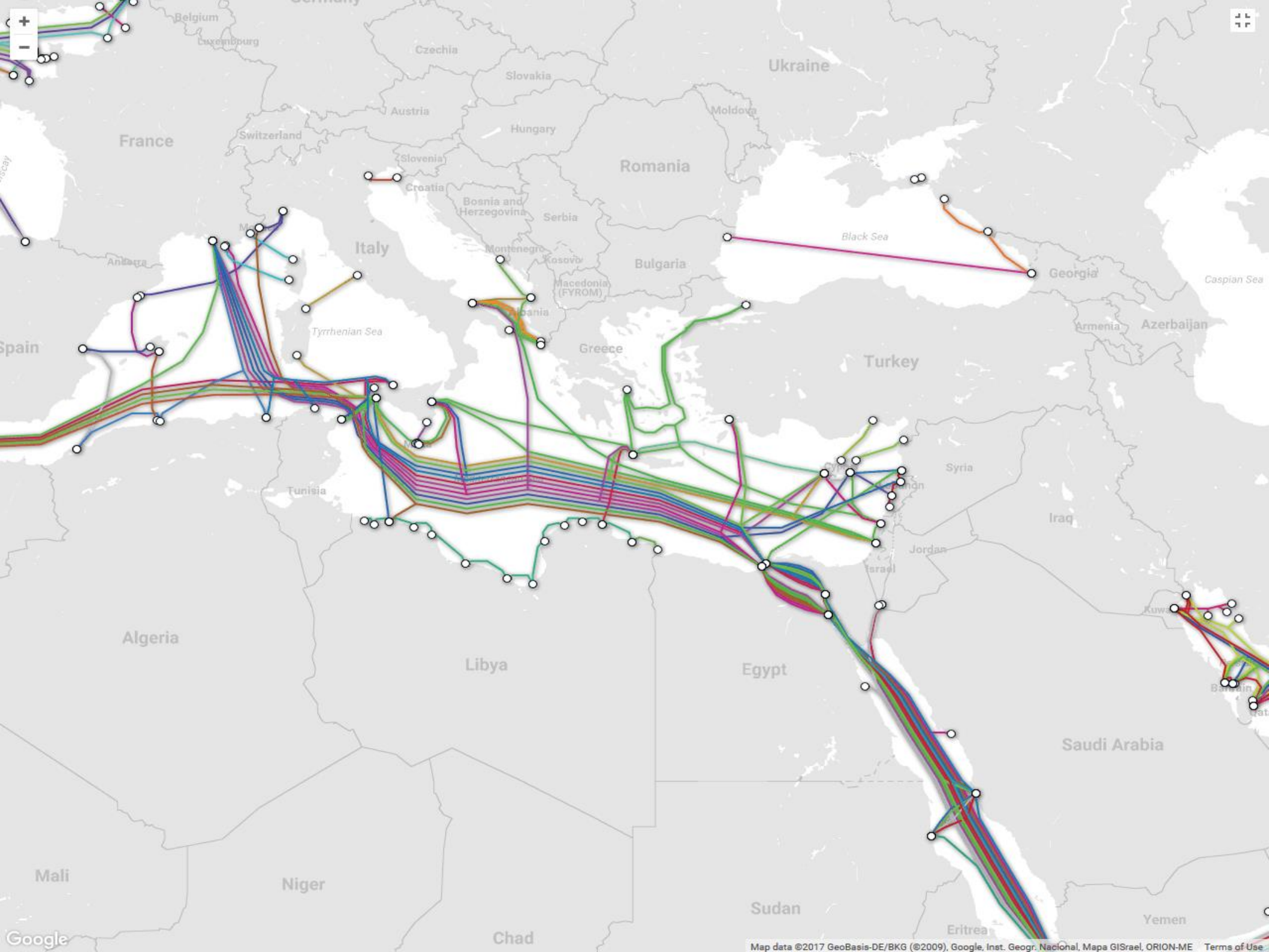

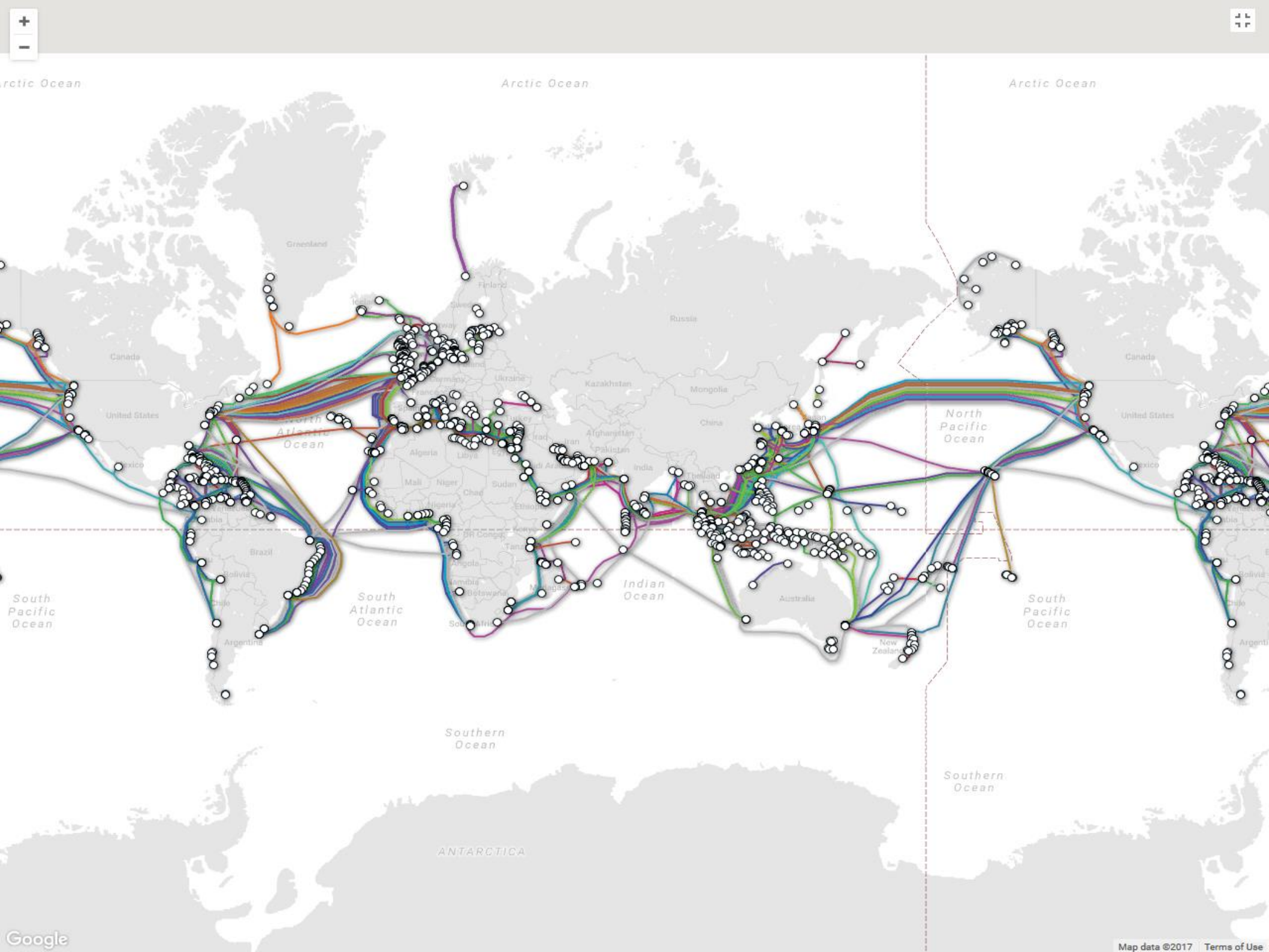

Arctic Ocean

Arctic Ocean

Arctic Ocean

Greenland

Finland

Russia

Canada

Canada

United States

United States

Mexico

Mexico

North Atlantic Ocean

North Pacific Ocean

South Atlantic Ocean

Indian Ocean

South Pacific Ocean

South Pacific Ocean

Brazil

Australia

Southern Ocean

Southern Ocean

ANTARCTICA

# ΤΗΛΕΠΙΚΟΙΝΩΝΙΑΚΟ ΣΥΣΤΗΜΑ

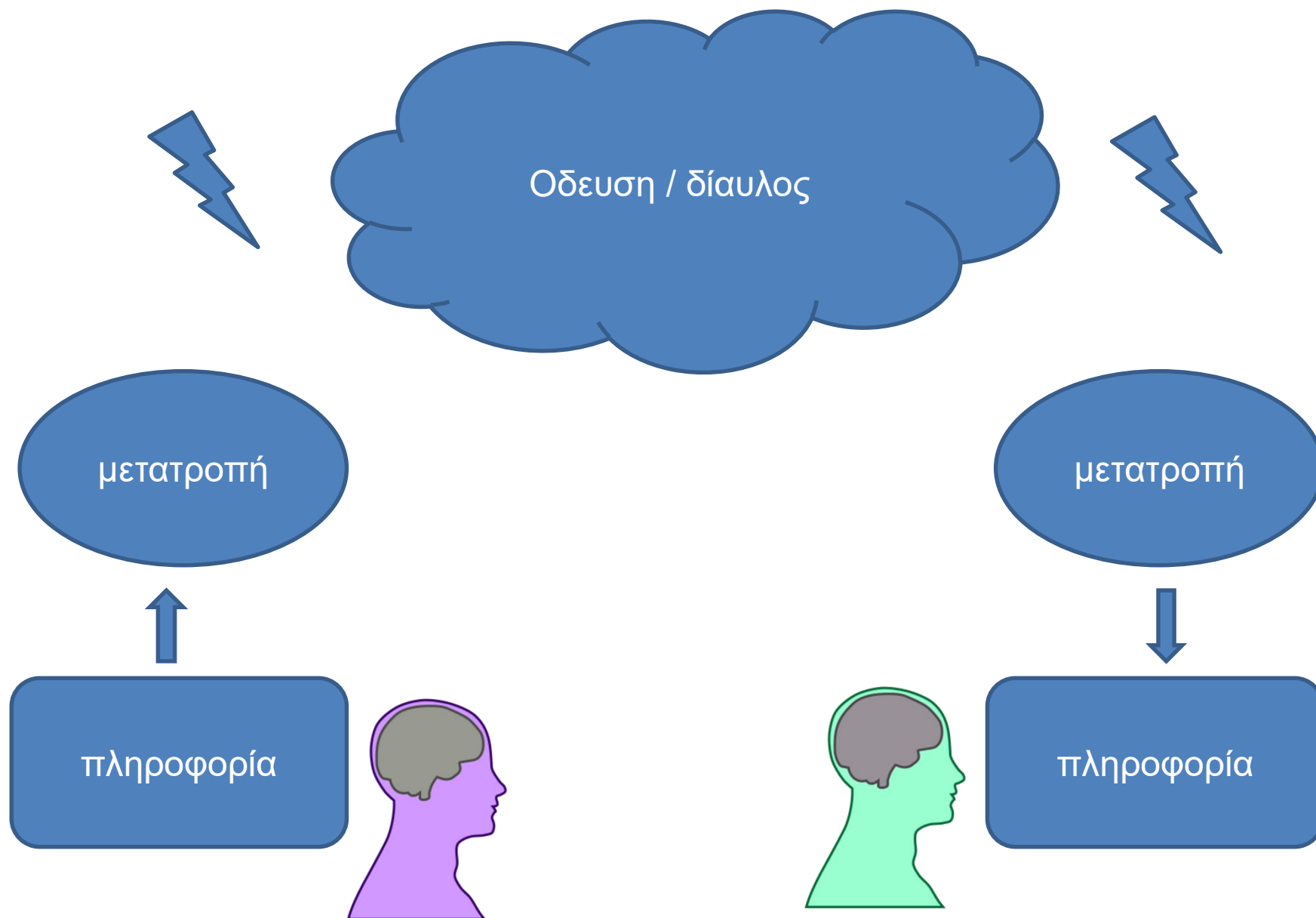



# ΔΙΑΜΟΡΦΩΣΗ ΠΛΗΡΟΦΟΡΙΑΣ



Ιεράρχηση  
Ομαδοποίηση  
Κωδικοποίηση  
Διαβίβαση  
Σαφήνεια  
Λιτότητα

σημαντικότητα  
περιεχόμενο  
Καταγραφή  
Μεταφορά  
Κατανόηση  
Όχι πλεονασμός

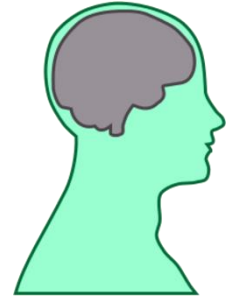

Αξιοπιστία ?  
Ακεραιότητα ?  
Επαλήθευση ?

# Synchronous Timing Diagram

---

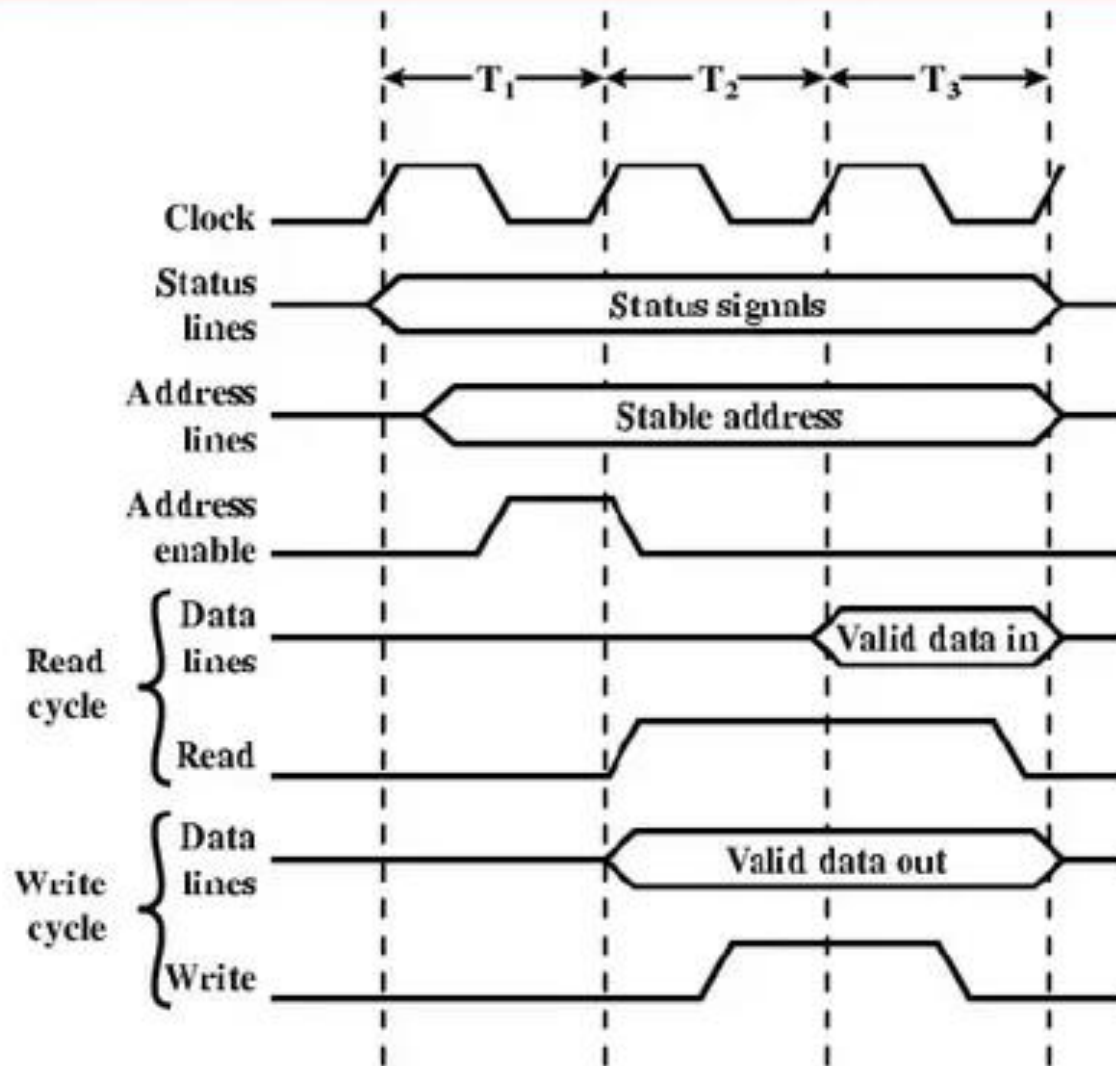

# Asynchronous Transmission

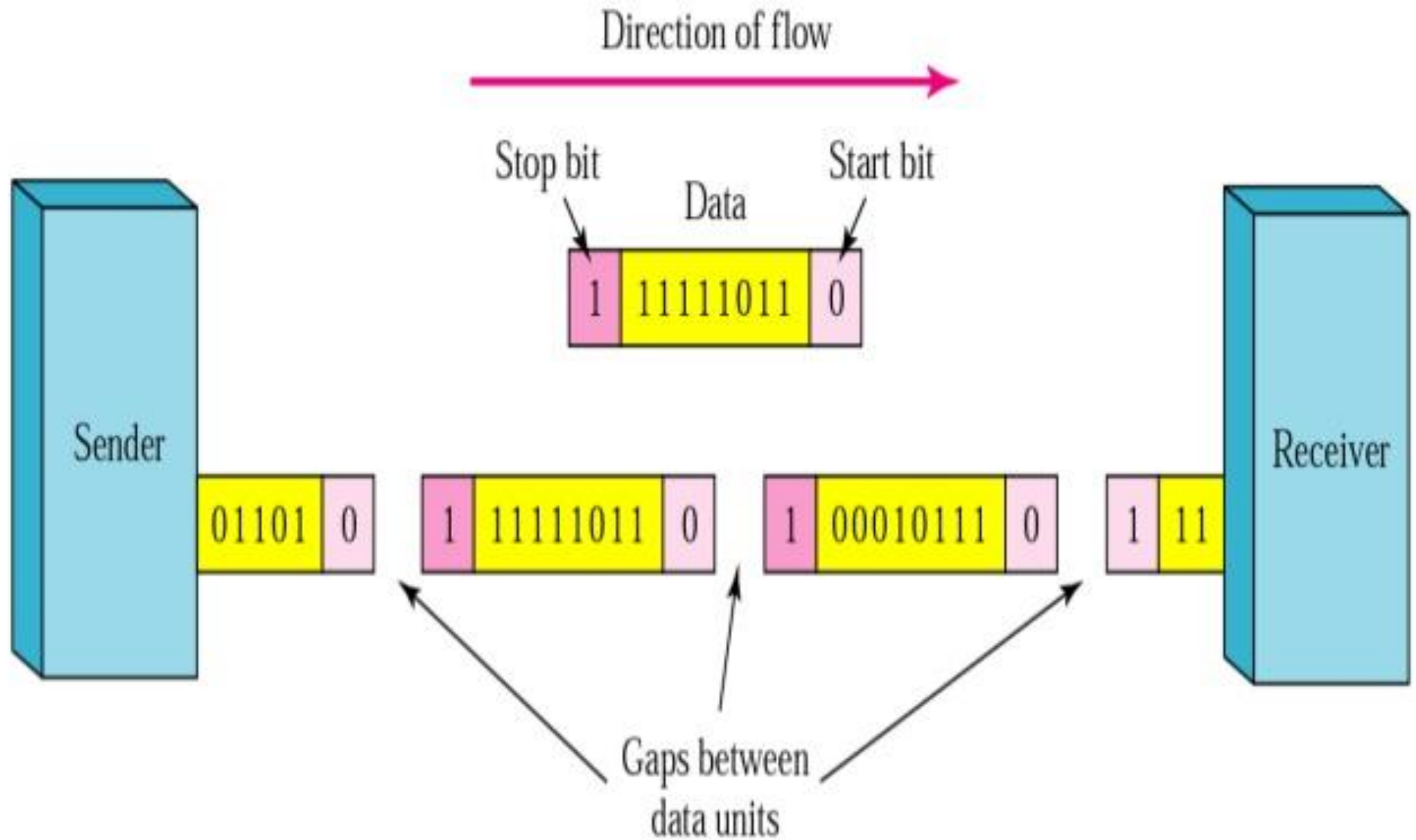

---

# Asynchronous Communication

- **In Asynchronous Communication**
  - the processes involved in communication are not required to participate at the point of communication simultaneously.
  - If Process A attempts to send a message and Process B is not ready to receive it sends it anyway.
  - If process B is ready to receive a message and A has not sent it process B must wait.
  - Asynchronous communication requires the use of buffers to store messages
  
- **All of the protocol specification methods studied in this course will be based upon Asynchronous Communication**

# Πρότυπα επικοινωνίας. OSI Model

OSI Model	Protocols
Application Layer	DNS, DHCP, FTP, HTTPS, IMAP, LDAP, NTP, POP3, RTP, RTSP, SSH, SIP, SMTP, SNMP, Telet, TFTP
Presentation Layer	JPEG, MIDI, MPEG, PICT, TIFF
Session Layer	NetBIOS, NFS, PAP, SCP, SQL, ZIP
Transport Layer	TCP, UDP
Network Layer	ICMP, IGMP, IPsec, IPv4, IPv6, IPX, RIP
Data Link Layer	ARP, ATM, CDP, FDDI, Frame Relay, HDLC, MPLS, PPP, STP, Token Ring
Physical Layer	Bluetooth, Ethernet, DSL, ISDN, 802.11 Wi-Fi

# Σύγκριση μοντέλων OSI – TCP/IP

## DATA

## OSI MODEL

## TCP MODEL

Data

**Application**

Network Process to Application

Data

**Presentation**

Data Representation and Encryption

Data

**Session**

Inter host Communication

Segment

**Transport**

End to End connection and reliability

Packet

**Network**

Best path determination and IP (Logical) Addressing

Frame

**Data Link**

MAC and LLC (Physical Addressing)

Bits

**Physical**

Media, Signal and Binary Transmission

Application

Transport

Internet

Network Access

# OSI Example for Ethernet Media - TCP/IP STACK

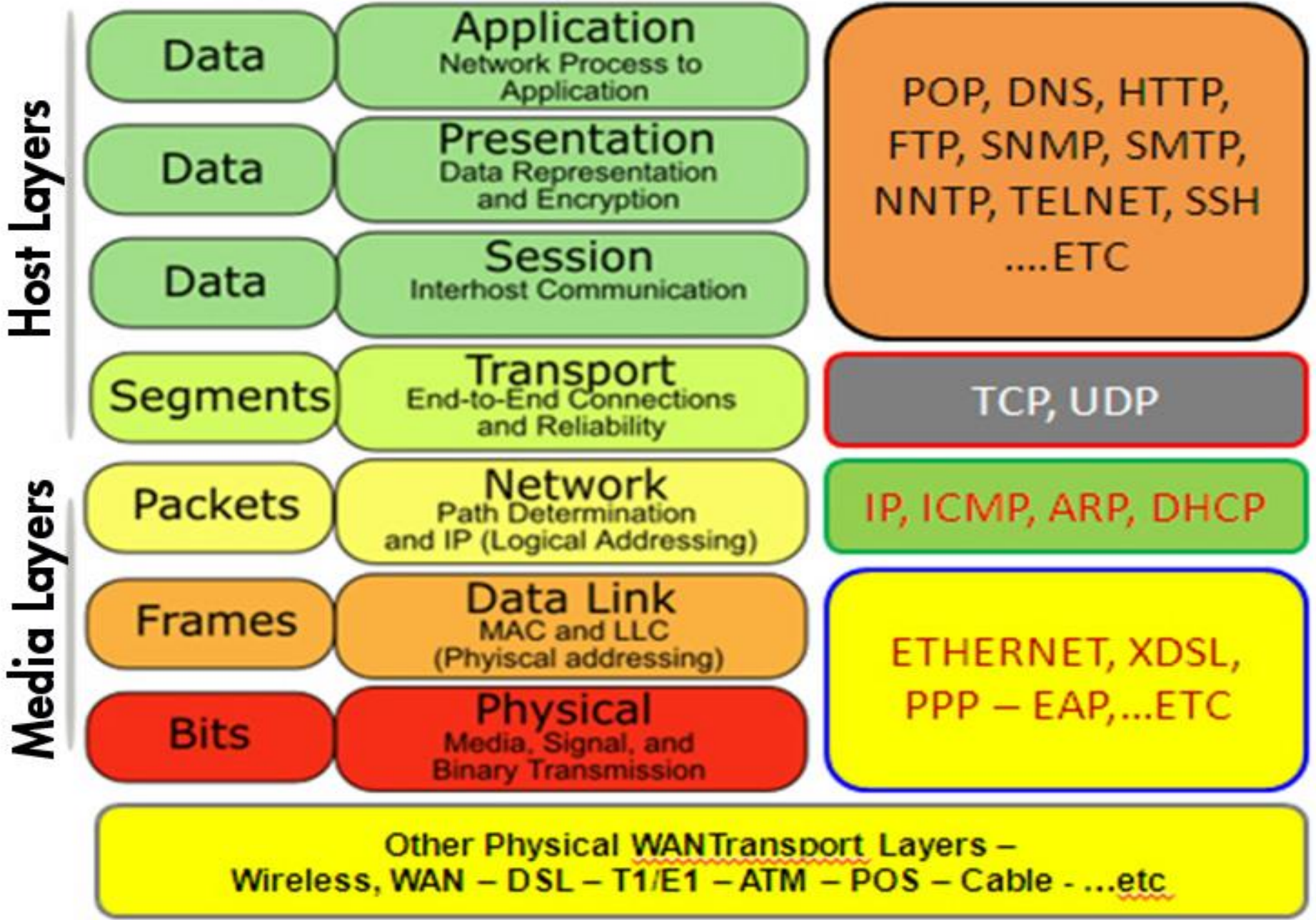

A networking model is only a representation of a network operation. The model is not the actual network.

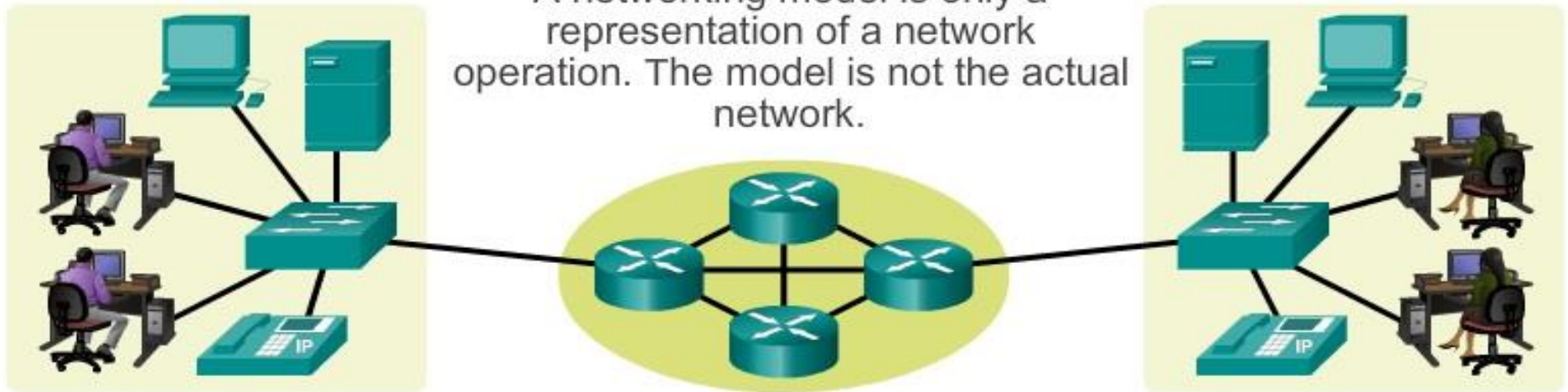

### OSI Model

### TCP/IP Protocol Suite

### TCP/IP Model

Application	HTTP, DNS, DHCP, FTP	Application
Presentation		
Session		
Transport	TCP, UDP	Transport
Network	IPv4, IPv6, ICMPv4, ICMPv6	Internet
Data Link	PPP, Frame Relay, Ethernet	Network Access
Physical		



# Ενθυλάκωση - Encapsulation

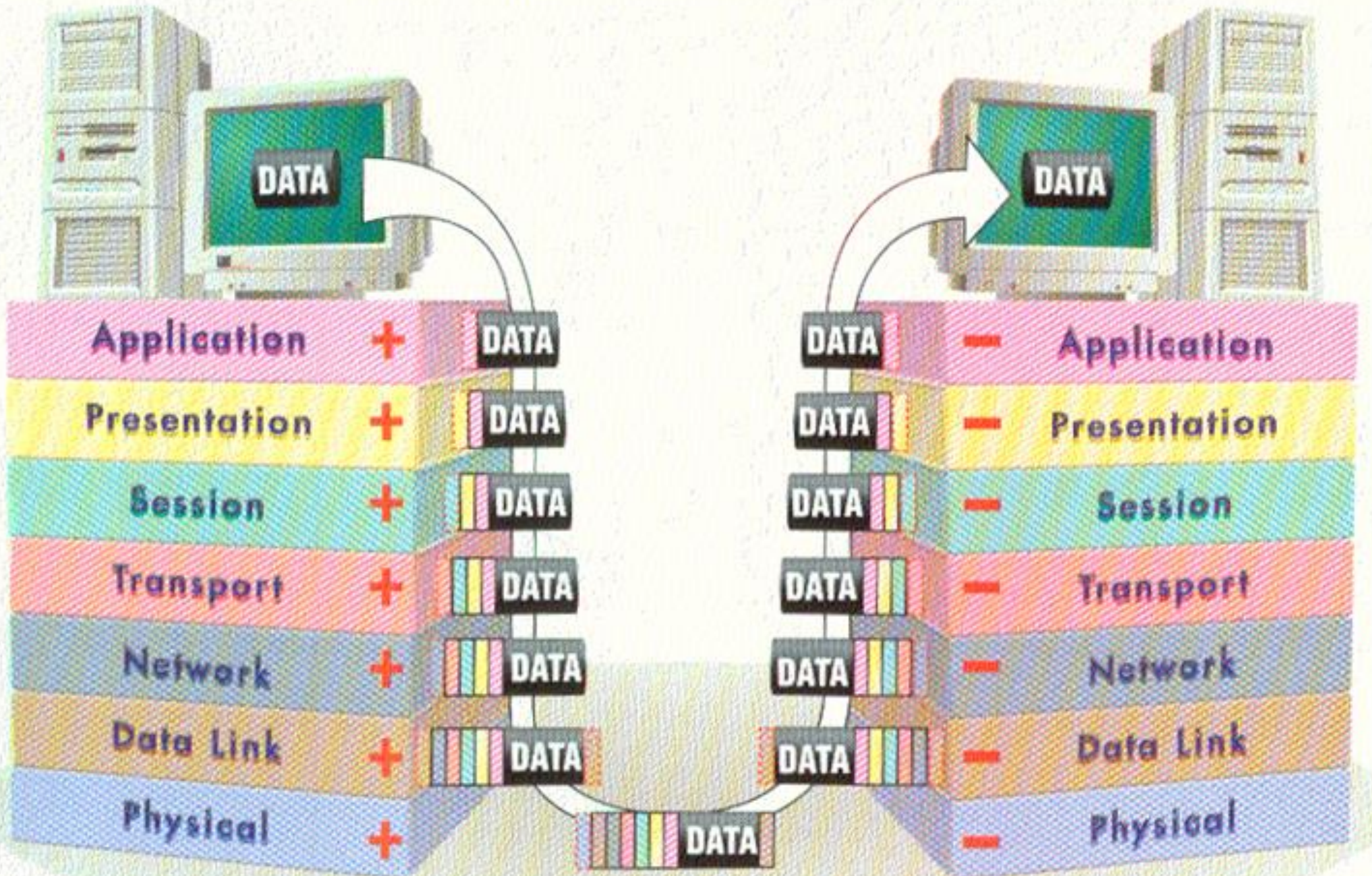

# Ενθυλάκωση - Encapsulation

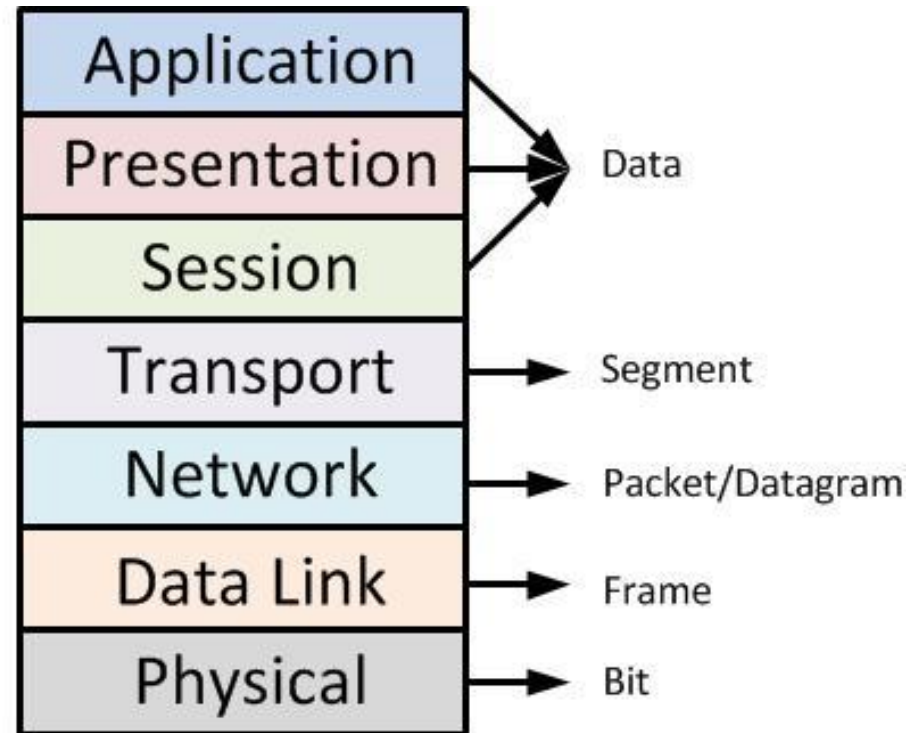
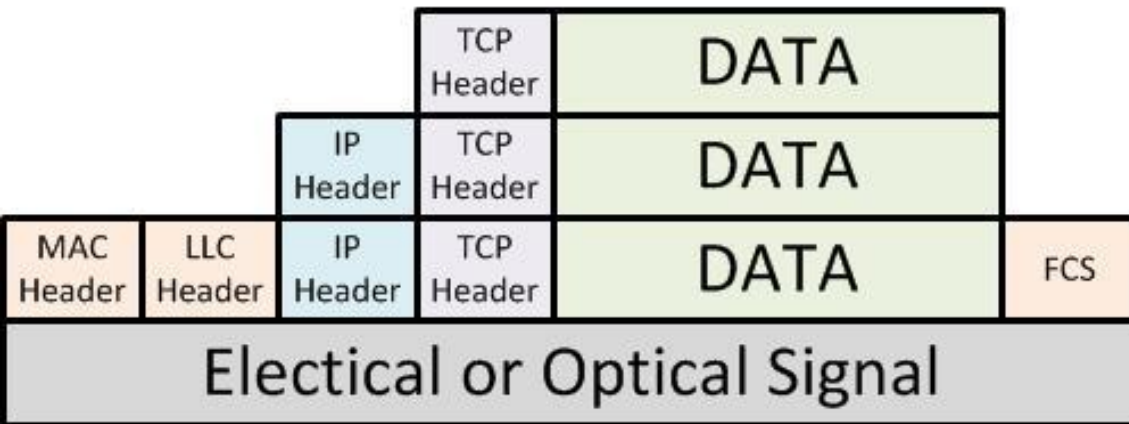

# ΕΙΔΗ ΕΠΙΚΟΙΝΩΝΙΑΣ

- Point to point communication
- Point to multi-point communication
- Broadcast communication
- Simplex communication
- Half-duplex communication
- Full-duplex communication

# ΤΟΠΟΛΟΓΙΑ ΕΠΙΚΟΙΝΩΝΙΑΣ

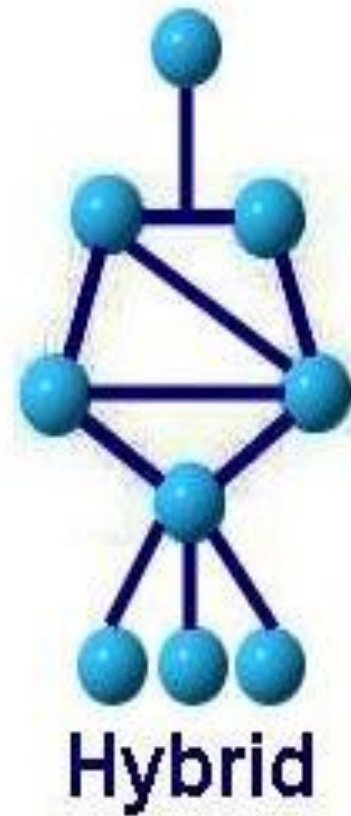
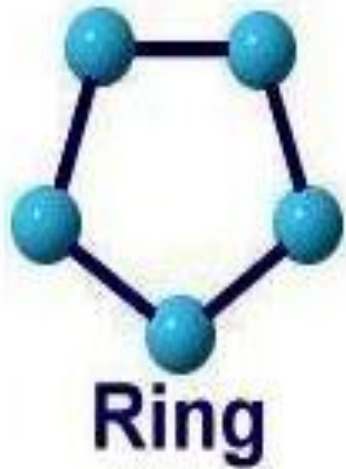
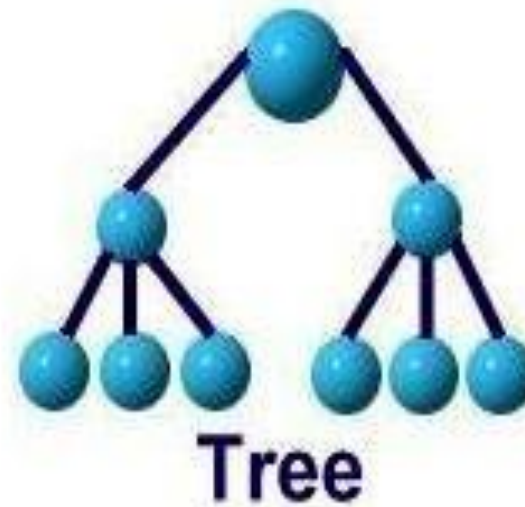
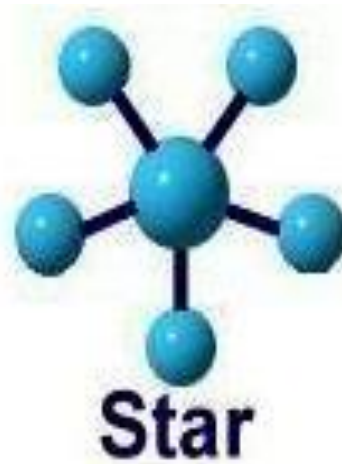
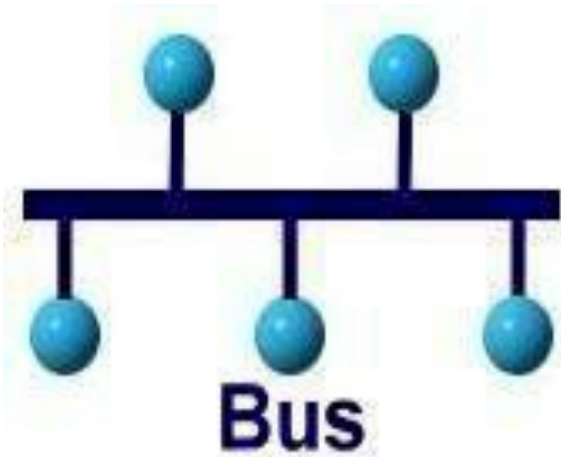

# ΤΟΠΟΛΟΓΙΑ ΔΙΚΤΥΟΥ

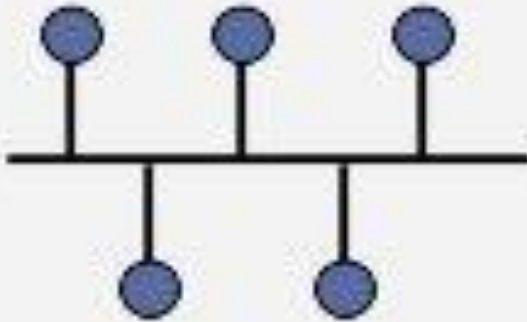

**Bus**

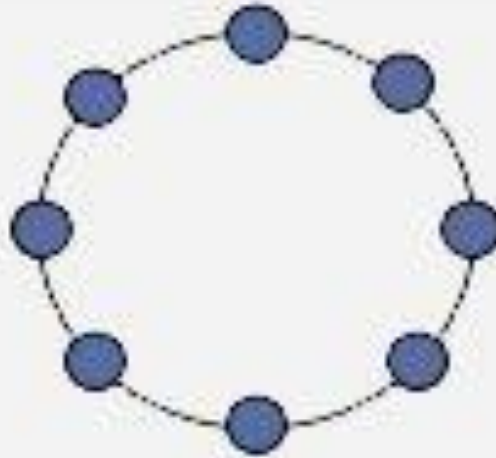

**Ring**

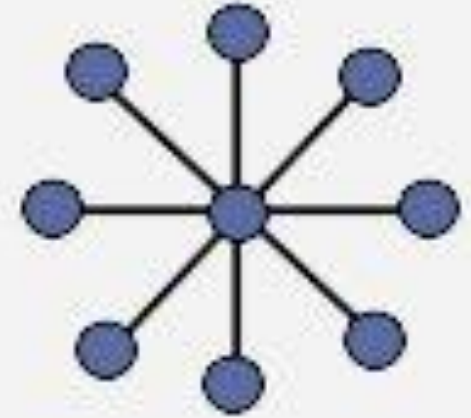

**Star**

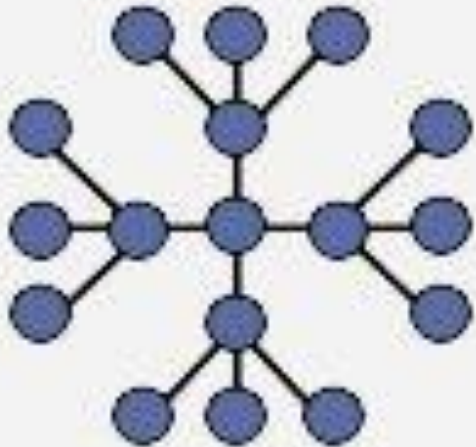

**Extended Star**

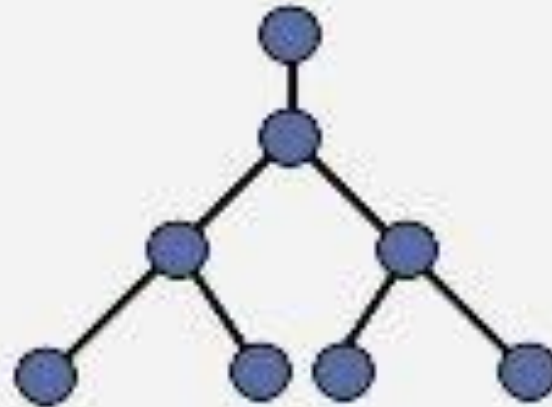

**Hierarchical**

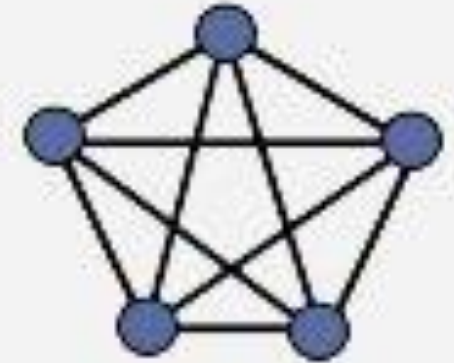

**Mesh**

# PSTN δίκτυο: δέσμευση καναλιού φωνής

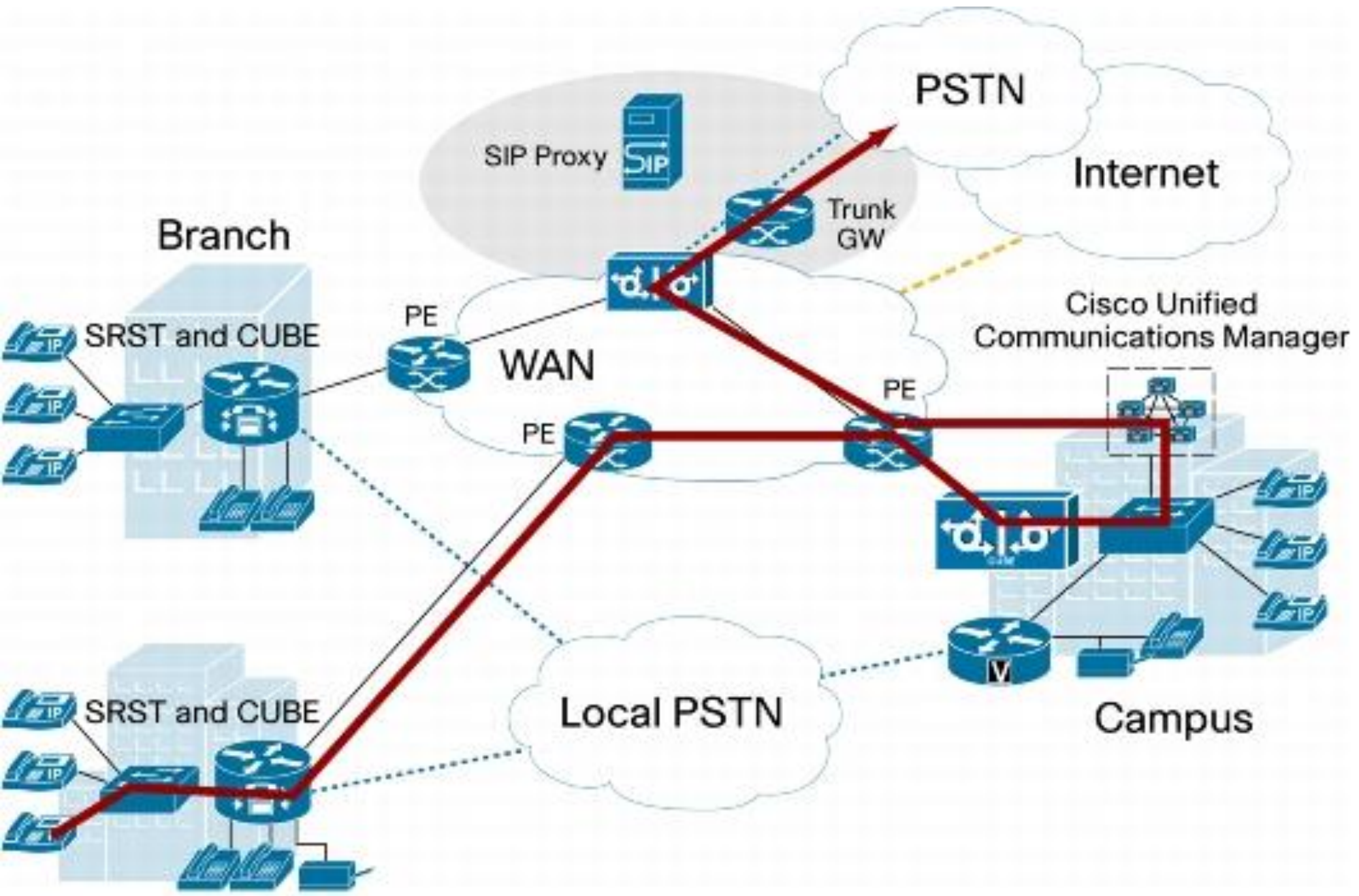

# Over IP δίκτυο: δεν υπάρχει συγκεκριμένο μονοπάτι διέλευσης. Τα πακέτα δρομολογούνται ανεξάρτητα

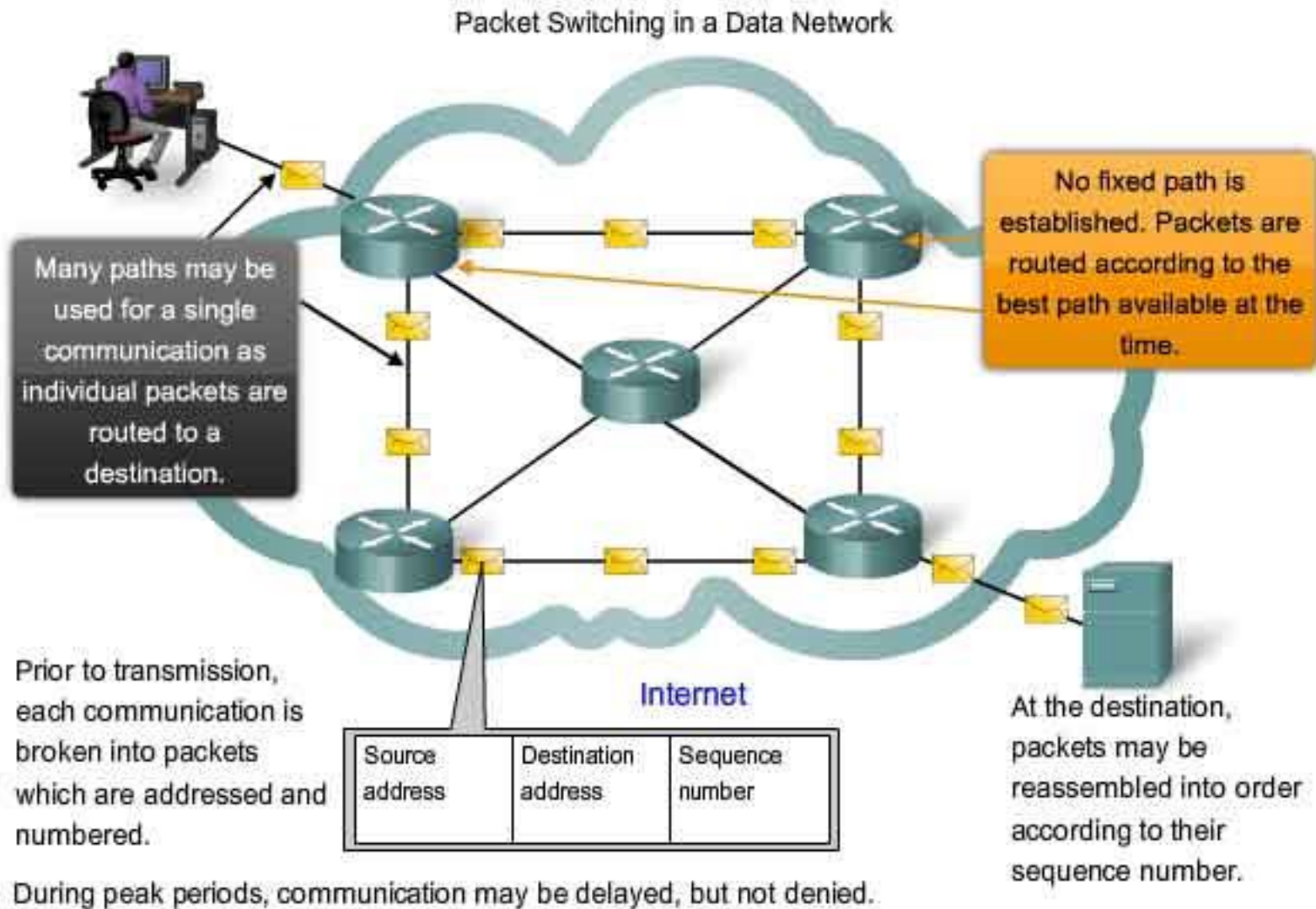

## ITU-T Security Building Blocks

### **Security Architecture and Frameworks**

- X.800 – Security architecture
- X.802 – Lower layers security model
- X.803 – Upper layers security model
- X.810 – Security frameworks for open systems: Overview
- X.811 – Security frameworks for open systems: Authentication framework
- X.812 – Security frameworks for open systems: Access control framework
- X.813 – Security frameworks for open systems: Non-repudiation framework
- X.814 – Security frameworks for open systems: Confidentiality framework
- X.815 – Security frameworks for open systems: Integrity framework
- X.816 – Security frameworks for open systems: Security audit and alarms framework

### **Telecommunication Security**

- E.408 – Telecommunication network security requirements
- E.409 – Incident organization and security incident handling: Guidelines for telecommunication organizations
- X.805 – Security architecture for systems providing end-to-end communications
- X.1051 – Information security management system – Requirements for telecommunications (ISMS-T)
- X.1081 – A framework for the specification of security and safety aspects of telediometrics
- X.1121 – Framework of security technologies for mobile end-to-end communications
- X.1122 – Guideline for implementing secure mobile systems based on PKI

### **Protocols**

- X.273 – Network layer security protocol
- X.274 – Transport layer security protocol

### **Security in Frame Relay**

- X.272 – Data compression and privacy over frame relay networks

### **Security Techniques**

- X.841 – Security information objects for access control
- X.842 – Guidelines for the use and management of Trusted Third Party (TTP) services
- X.843 – Specification of TTP services to support the application of digital signatures

### **Directory Services and Authentication**

- H.350 – Series – Directory services architecture for multimedia conferencing
- X.500 – Overview of concepts models and services
- X.501 – Models
- X.509 – Public-key and attribute certificate frameworks
- X.519 – Protocol specifications

### **Network Management Security**

- M.3010 – Principles for a telecommunication management network
- M.3016 – TMN security overview
- M.3210.1 – TMN management services for IMT-2000 security management
- M.3320 – Management requirements framework for the TMN X-Interface
- M.3400 – TMN management functions

### **Systems Management**

- X.733 – Alarm reporting function
- X.735 – Log control function
- X.736 – Security alarm reporting function
- X.740 – Security audit trail function
- X.741 – Objects and attributes for access control

### **Televisions and Cable Systems**

- J.91 – Technical methods for ensuring privacy in long-distance international television transmission
- J.93 – Requirements for conditional access in the secondary distribution of digital television on cable television systems
- J.170 – IP-Cablecom security specification

### **Multimedia Communications**

- H.233 – Confidentiality system for audiovisual services
- H.234 – Encryption key management and authentication system for audiovisual services
- H.235 – Security and encryption for H-series multimedia systems
- H.323 Annex J – Packet based multimedia communications systems – Security for simple endpoint types
- H.530 – Symmetric security procedures for H.323 mobility in H.510
- T.123 Annex B – Network-specific data protocol stacks for multimedia conferencing: extended transport connections

### **Facsimile**

- T.36 – Security capabilities for use with Group 3 facsimile terminals
- T.503 – A document application profile for the interchange of Group 4 facsimile documents
- T.563 – Terminal characteristics for Group 4 facsimile apparatus

### **Message Handling Systems (MHS)**

- X.400 / F.400 – Message handling system and service overview
- X.402 – Overall architecture
- X.411 – Message transfer system: Abstract service definition and procedures
- X.413 – Message store: Abstract service definition
- X.419 – Protocol specifications
- X.420 – Interpersonal messaging system
- X.435 – Electronic data interchange messaging system
- X.440 – Voice messaging system

ITU-T Recommendations are available from the ITU website. See <http://www.itu.int/publications/bookshop/how-to-buy.html>  
(this site includes information on limited free access to ITU-T Recommendations)



# ΔΙΑΔΙΚΤΥΟ - INTERNET

